



YAMAHA

B G

RX-V595RDS

Natural Sound AV Receiver

Récepteur audiovisuel

**OWNER'S MANUAL
MODE D'EMPLOI
BEDIENUNGSANLEITUNG
BRUKSANVISNING
MANUALE DI ISTRUZIONI
MANUAL DE INSTRUCCIONES
GEBRUIKSAANWIJZING**

SUPPLIED ACCESSORIES
ACCESSOIRES FOURNIS
MITGELIEFERTE ZUBEHÖRTEILE
MEDFÖLJANDE TILLBEHÖR
ACCESSORI IN DOTAZIONE
ACCESORIOS INCLUIDOS
BIJGELEVERDE ACCESSOIRES

- After unpacking, check that the following parts are included.
- Après le déballage, vérifier que les pièces suivantes sont incluses.
- Nach dem Auspacken überprüfen, ob die folgenden Teile vorhanden sind.
- Kontrollera efter det apparaten packats upp att följande delar finns med.
- Verificare che tutte le parti seguenti siano contenute nell'imballaggio dell'apparecchio.
- Desembalar el aparato y verificar que los siguientes accesorios están en la caja.
- Controleer na het uitpakken of de volgende onderdelen voorhanden zijn.

- Indoor FM Antenna
- Antenne FM intérieure
- UKW-Innenantenne
- Inomhus-FM-antenn
- Antenna FM interna
- Antena FM interior
- FM-binnenantenne

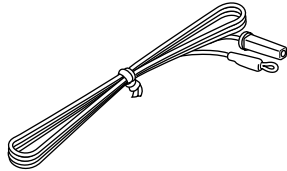

- AM Loop Antenna
- Cadre-antenne AM
- MW-Rahmenantenne
- AM-ramantenn
- Antenna AM ad anello
- Antena de cuadro de AM
- AM-raamantenne

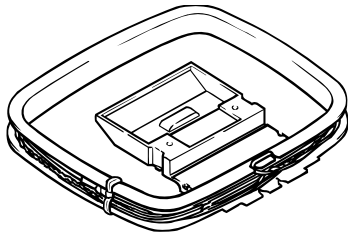

- 75-ohm/300-ohm antenna adapter (U.K. model only)
- Adaptateur d'antenne 75 ohms/300 ohms (Modèle Royaume-Uni seulement)
- 75-Ohm/300-Ohm Antennenstecker (nur Großbritannien-Modell)
- 75 ohm/300 ohm antennadapter (gäller endast modellerna för Storbritannien)
- Adattatore per antenna da 75 e 300 ohm (Soltanto il modello per la Gran Bretagna)
- Adaptador de antena de 75-ohmios/300-ohmios (Sólo el modelo para el Reino Unido)
- 75 ohm/300 ohm antennadapter (Alleen modellen voor Verenigd Koninkrijk)

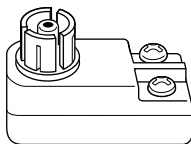

- Batteries (size AA, R6, UM-3)
- Piles (taille AA, R6, UM-3)
- Batterien (Größe AA, R6, UM-3)
- Batterier (storlek AA, R6, UM-3)
- Batterie (dimensioni AA, R6, UM-3)
- Pilas (tamaño AA, R6, UM-3)
- Batterijen (maat AA, R6, UM-3)

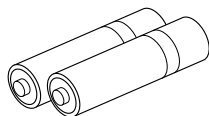

- Remote control transmitter
- Télécommande
- Fernbedienung
- Fjärrkontroll
- Telecomando
- Transmisor de control remoto
- Afstandsbediening

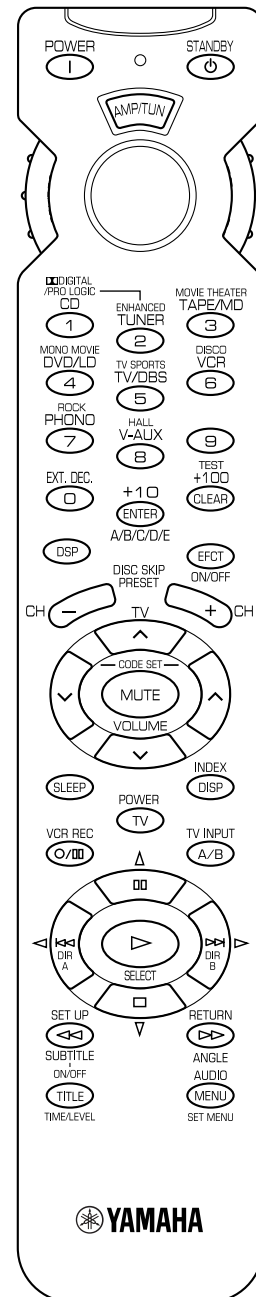

FEATURES

- **5 Speaker Configuration**
 - Main:** 65 W + 65 W (8Ω) RMS Output
Power, 0.04% THD, 20 Hz – 20 kHz
 - Center:** 65 W (8Ω) RMS Output
Power, 0.04% THD, 20 Hz – 20 kHz
 - Rear:** 65 W + 65 W (8Ω) RMS Output
Power, 0.04% THD, 20 Hz – 20 kHz
- **Digital Sound Field Processor**
- **Dolby Digital Decoder**
- **Dolby Pro Logic Surround Decoder**
- **CINEMA DSP: Theater-like Sound Experience by the Combination of Dolby Surround and YAMAHA DSP Technology**
- **6-Channel External Decoder Input for DTS and other future formats**
- **Automatic Input Balance Control for Dolby Pro Logic Surround**
- **Test Tone Generator for Easier Speaker Balance Adjustment**
- **Speaker Output Mode Changing Capability**
- **40-Station Random Access Preset Tuning**
- **Automatic Preset Tuning**
- **Preset Station Shifting Capability (Preset Editing)**
- **Video Signal Input/Output Capability (Including S Video Connections)**
- **SLEEP Timer**
- **Universal Remote Control Transmitter with Preset Manufacturer Codes**

CONTENTS

SUPPLIED ACCESSORIES	2	● Information about DSP	
FEATURES	3	USING DIGITAL SOUND FIELD	
CAUTION	4	PROCESSOR (DSP)	40
● Introduction		● Advanced Information	
FEATURES ON SOUND EFFECT	5	ADJUSTMENTS	
CONTROLS AND THEIR FUNCTIONS	7	IN THE "SET MENU" MODE	46
● Preparation		● Remote Control Transmitter	
SPEAKER SETUP	10	REMOTE CONTROL TRANSMITTER	48
CONNECTIONS	12	SETUP CODES	53
ADJUSTMENTS		NOTES ABOUT THE REMOTE CONTROL	
BEFORE USING THIS UNIT	20	TRANSMITTER	54
● Basic Operation		TROUBLESHOOTING	55
BASIC OPERATIONS	25	SPECIFICATIONS	57
TUNING OPERATIONS	29	LIST OF MANUFACTURER'S CODES	397
RECEIVING RDS STATIONS	34		
SETTING THE SLEEP TIMER	39		

CAUTION : READ THIS BEFORE OPERATING YOUR UNIT.

1. To assure the finest performance, please read this manual carefully. Keep it in a safe place for future reference.
2. Install this unit in a cool, dry, clean place – away from windows, heat sources, sources of excessive vibration, dust, moisture and cold. Avoid sources of humming (transformers, motors). To prevent fire or electrical shock, do not expose the unit to rain or water.
3. Never open the cabinet. If something drops into the set, contact your dealer.
4. Do not use force on switches, controls or connection wires. When moving the unit, first disconnect the power plug and the wires connected to other equipment. Never pull the wires themselves.
5. The openings on the unit cover assure proper ventilation of the unit. If these openings are obstructed, the temperature inside the unit will rise rapidly. Therefore, avoid placing objects against these openings, and install the unit in a well-ventilated area to prevent fire and damage.

Be sure to allow a space of at least 20 cm behind, 20 cm on the both sides and 30 cm above the top panel of the unit to prevent fire and damage.
6. The voltage used must be the same as that specified on this unit. Using this unit with a higher voltage than specified is dangerous and may result in fire or other accidents. YAMAHA will not be held responsible for any damage resulting from use of this unit with a voltage other than specified.
7. Digital signals generated by this unit may interfere with other equipment such as tuners, receivers or TVs. Move this unit farther away from such equipment if interference is observed.
8. Always set the VOLUME control to “∞” before starting the audio source play. Increase the volume gradually to an appropriate level after playback has been started.
9. Do not attempt to clean the unit with chemical solvents; this might damage the finish. Use a clean, dry cloth.
10. Be sure to read the “TROUBLESHOOTING” section regarding common operating errors before concluding that the unit is faulty.
11. When not planning to use this unit for long periods of time (ie., vacation, etc.), disconnect the AC power plug from the wall outlet.
12. To prevent lightning damage, disconnect the AC power plug and disconnect the antenna cable when there is an electrical storm.
13. Grounding or polarization – Precautions should be taken so that the grounding or polarization of an appliance is not defeated.
14. AC outlet
Do not connect audio equipment to the AC outlet on the rear panel if that equipment requires more power than the outlet is rated to provide.

For U.K. customers

If the socket outlets in the home are not suitable for the plug supplied with this appliance, it should be cut off and an appropriate 3 pin plug fitted. For details, refer to the instructions described below.

Note: The plug severed from the mains lead must be destroyed, as a plug with bared flexible cord is hazardous if engaged in a live socket outlet.

Special Instructions for U.K. Model

IMPORTANT

THE WIRES IN THE MAINS LEAD ARE COLOURED IN ACCORDANCE WITH THE FOLLOWING CODE:

Blue: NEUTRAL

Brown: LIVE

As the colours of the wires in the main lead of this apparatus may not correspond with the coloured markings identifying the terminals in your plug, proceed as follows:

The wire which is coloured BLUE must be connected to the terminal which is marked with the letter N or coloured BLACK. The wire which is coloured BROWN must be connected to the terminal which is marked with the letter L or coloured RED. Make sure that neither core is connected to the earth terminal of the three pin plug.

This unit is not disconnected from the AC power source as long as it is connected to the wall outlet, even if this unit itself is turned off. This state is called the standby mode. In this state, this unit is designed to consume a very small quantity of power.

FEATURES ON SOUND EFFECT

This unit incorporates a sophisticated, multi-program digital sound field processor. The processor allows you to electronically expand and change the shape of the audio sound field from both audio and video sources, creating a theater-like experience in your listening room. This unit has a total of 8 digital sound field processor (DSP) modes. You can create an excellent audio sound field by selecting a suitable sound field (this will, of course, depend on what you will be listening to), and adding desired adjustments.

Digital Sound Field Processing

What is it that makes live music so good? Today's advanced sound reproduction technology lets you get extremely close to the sound of a live performance, but chances are you'll still notice something missing, the acoustic environment of the live concert hall. Extensive research into the exact nature of the sonic reflections that create the ambience of a large hall has made it possible for YAMAHA engineers to bring you this same sound in your listening room, so you'll feel all the sound of a live concert.

Dolby Pro Logic Surround

This unit employs a Dolby Pro Logic Surround decoder similar to professional Dolby Stereo decoders used in many movie theaters. By using the Dolby Pro Logic Surround decoder, you can experience the dramatic realism and impact of Dolby Surround movie theater sound in your own home. Dolby Pro Logic employs a four channel five speaker system. The Pro Logic Surround system divides the input signal into four levels: the left and right main channels, the center channel (used for dialog), and the rear surround sound channels (used for sound effects, background noise, and other ambient noises). The center channel allows listeners seated in even less-than-ideal positions to hear the dialog originating from the action on the screen while experiencing good stereo imaging.

Dolby Digital

The built-in Dolby Digital decoder leads you into a totally new sound experiences.

Dolby Digital is a new generation of multi-channel digital audio technology, or the newest spatial sound processing format developed for 35 mm film-movies by employing a new kind of low bit-rate audio coding.

Dolby Digital is a digital surround sound system that provides completely independent multi-channel audio to consumers. In multi-channel form, Dolby Digital provides five full range channels in what is sometimes referred to as a "3/2" configuration: three front channels (left, center and right), plus two surround channels. A sixth bass-only effect channel is also provided for output of LFE (low frequency effect), or low bass effects that are independent of other channels. This channel is counted as 0.1, thus giving rise to the term 5.1 channels in total.

In addition, this unit incorporates a Dolby Pro Logic Surround decoder and Dolby Digital decoder for multi-channel sound reproduction of Dolby Surround encoded video sources. The operation of the Dolby Pro Logic Surround or Dolby Digital decoder can be controlled by selecting a corresponding DSP program including combined operations of the YAMAHA DSP and the Dolby Pro Logic Surround or Dolby Digital decoder.

Furthermore, our technicians, armed with sophisticated measuring equipment, have even made it possible to capture the acoustics of a variety of actual concert halls, theaters, etc. from around the world, to allow you to accurately re-create any one of these live performance environments, all in your home.

Dolby Surround is encoded on the sound track of pre-recorded video tapes, laser discs, and some TV/cable broadcasts. When you play a source encoded with Dolby Surround on this unit, the Dolby Pro Logic Surround decoder decodes the signal and distributes the surround-sound effects.

This Dolby Pro Logic Surround decoder employs a digital signal processing system. This system improves the stability of sound at each channel and crosstalk between channels, so that positioning of sounds around the room is more accurate compared with conventional analog signal processing systems.

In addition, this unit features a built-in automatic input balance control. This always assures you the best performance without manual adjustment.

Compared to Dolby Pro Logic that is referred to a "3/1" system (left front, center, right front and just one surround channel), Dolby Digital features two surround channels, called stereo or split surrounds, each offering the same full range fidelity as the three front channels.

Sound of wide dynamic range reproduced by the five full range channels presents listeners much excitement that has never been experienced before. Precise sound orientation by the discrete digital sound processing expands realism that the original movie possesses.

LD and DVD are home audio formats that could benefit from Dolby Digital. In the near future, Dolby Digital will also be applied to DBS, CATV and HDTV. The ongoing release of Dolby Stereo Digital theatrical films now underway will provide an immediate source of Dolby Digital encoded video software.



Manufactured under license from Dolby Laboratories Licensing Corporation. "Dolby", "Pro Logic", and the double-D symbol are trademarks of Dolby Laboratories Licensing Corporation. Copyright 1992 Dolby Laboratories, Inc. All rights reserved.

The following original functions make the surround-sound effect of Dolby Digital become the most suitable for your audio system and the listening conditions.

Dolby Surround + DSP (CINEMA DSP)

Dolby Surround sound system shows its full ability in a large movie theater, because movie sounds are originally designed to be reproduced in a large movie theater using many speakers. It is difficult to create a sound environment similar to that of a movie theater in your listening room, because the room size, materials of inside walls, the number of speakers, etc. of your listening room is much different from those of a movie theater.

- **Dynamic range (sound scale) of source can be changed so that it will be suitable for the listening conditions.**
- **Output of low bass from any channel can be assigned to either the MAIN SPEAKERS terminals or SUBWOOFER terminal to maximize system performance.**
- **Output of LFE can be assigned to either the MAIN SPEAKERS terminals or SUBWOOFER terminal to maximize system performance.**

YAMAHA DSP technology made it possible to present you with nearly the same sound experience as that of a large movie theater in your listening room by compensating for lack of presence and dynamics in your listening room with its original digital sound fields combined with Dolby Surround sound field.

CINEMA DSP

The YAMAHA "CINEMA DSP" logo indicates those programs are created by the combination of Dolby Surround and YAMAHA DSP technology.

Dolby Pro Logic + 2 Digital Sound Fields

Digital sound fields are created on the presence side and the rear surround side of the Dolby Pro Logic Surround-decoded sound field respectively. They create a wide acoustic environment and emphasize surround-effect in the room, letting you feel much presence as if you are watching a movie in a popular Dolby Stereo theater.

This combination is available when the sound field program **DOLBY PRO LOGIC ENHANCED/DOLBY DIGITAL ENHANCED, 70 mm MOVIE THEATER/DIGITAL MOVIE THEATER** or **TV SPORTS** is selected, and the input signal of source is analog, PCM audio or encoded with the Dolby Digital in 2-channel.

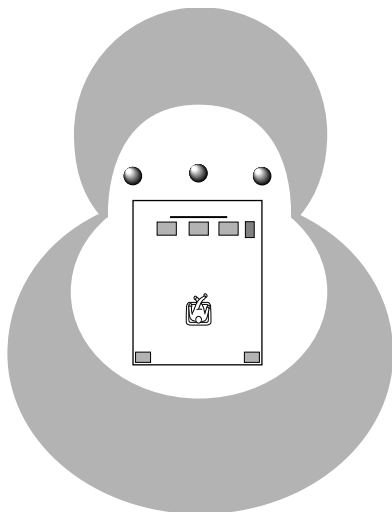

Dolby Digital + 3 Digital Sound Fields

Digital sound fields are created on the presence side and the independent left and right surround sides of the Dolby Digital-decoded sound field respectively. They create a wide acoustic environment and much surround effect in the room without losing high channel separation. With wide dynamic range of Dolby Digital sound, this sound field combination lets you feel as if you are watching a movie in the newest Dolby Stereo Digital theater. This will be the most ideal home theater sound at the present time.

This combination is available when the sound field program **DOLBY PRO LOGIC ENHANCED/DOLBY DIGITAL ENHANCED, 70 mm MOVIE THEATER/DIGITAL MOVIE THEATER** or **TV SPORTS** is selected, and the input signal of source is encoded with the Dolby Digital (except in 2-channel).

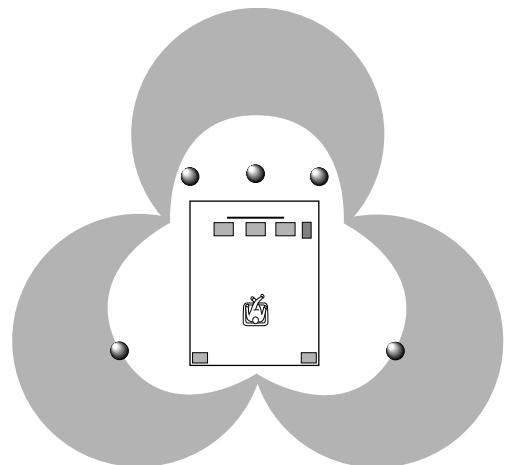

FRONT PANEL

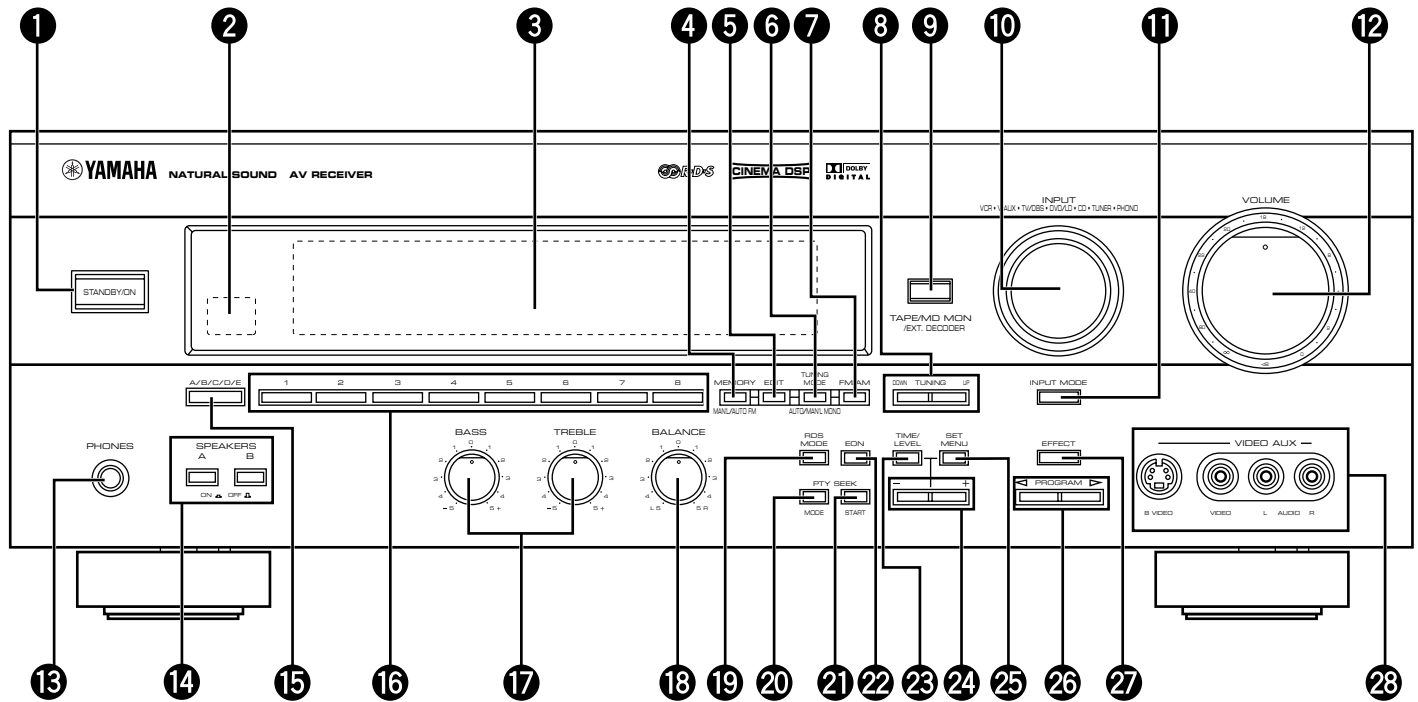

1 STANDBY/ON

Press this switch to turn the power of this unit on. Press it again to turn this unit into the standby mode.

Standby mode

In this state, this unit consumes a very small quantity of power to receive infrared-signals from the remote control transmitter.

2 Remote control sensor

Receives signals from the remote control transmitter.

3 Display

Shows various information. (For details, refer to page 9.)

4 MEMORY (MAN'L/AUTO FM)

Press this button to store the broadcasting stations. When this button is pressed and held for more than three seconds, the automatic preset tuning begins.

5 EDIT

This button is used to exchange the places of two preset stations with each other.

6 TUNING MODE (AUTO/MAN'L MONO)

Press this button to switch the tuning mode to automatic or manual. To select the automatic tuning mode, press this button so that the "AUTO TUNING" indicator lights up on the display. To select the manual tuning mode, press this button so that the "AUTO TUNING" indicator goes off.

7 FM/AM

Press this button to switch the reception band to FM or AM.

8 TUNING UP/DOWN

This button is used for tuning. Press the UP side to tune in to higher frequencies, and press the DOWN side to tune in to lower frequencies.

9 TAPE/MD MON / EXT. DECODER

Press this button to play a tape or an MD. The "TAPE/MD MON" indicator lights up on the display. When you press the button next, the "TAPE/MD MON" indicator goes off and "EXT. DECDR" appears on the display and you can play the signal connected to the **EXTERNAL DECODER INPUT** terminals.

10 INPUT

Turn this selector to select the program source (VCR, VIDEO AUX, TV/DBS, DVD/LD, CD, TUNER, PHONO) to listen to or watch.

The name of the selected program source appears on the display.

11 INPUT MODE

Switches the DVD/LD and TV/DBS input signal mode (AUTO/ANALOG).

12 VOLUME

This control is used to raise or lower the volume level.

13 PHONES jack

When you use headphones, connect the headphones to the **PHONES** jack. You can listen to the sound to be output from the main speakers through headphones.

When using headphones only, set both **SPEAKERS A** and **B** to the OFF position and switch off the digital sound field processor (so that no DSP program name appears on the display) by pressing **EFFECT**.

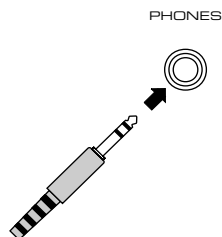

14 SPEAKERS

Set **A** or **B** (or both **A** and **B**) to the ON position for the main speaker system (connected to this unit) you will use. Set it (or them) for the main speaker system you will not use to the OFF position.

15 A/B/C/D/E

Press this button to select a group (A to E) of preset stations.

16 Preset station number selector

Select a preset station number (1 to 8).

17 Tone controls

These controls are effective only for the sound from the main speakers.

BASS

Used to increase or decrease the low frequency response. The "0" position produces flat response.

TREBLE

Used to increase or decrease the high frequency response. The "0" position produces flat response.

18 BALANCE

This control is effective only for the sound from the main speakers.

Adjusts the balance of the output volume to the left and right speakers to compensate for sound imbalance caused by speaker location or listening room conditions.

19 RDS MODE

When an RDS station is received, pressing this button changes the display mode into the PS mode, PTY mode, RT mode and/or CT mode (if the station employs those RDS data services) in turn.

20 PTY SEEK MODE

When this button is pressed, the unit turns into the PTY SEEK mode.

21 PTY SEEK START

Press this button to begin searching for a station after the desired program type is selected in the PTY SEEK mode.

22 EON

Press this button to select a desired program type (NEWS, INFO, AFFAIRS, SPORT) when you want to call a radio program of that program type automatically.

23 TIME/LEVEL

Press this button to select the setting of delay time or speaker output levels in the TIME/LEVEL mode.

24 +/-

These buttons are used to adjust settings of the SET MENU mode and the TIME/LEVEL mode. In the TIME/LEVEL mode, press **+** to increase delay time or speaker output levels. Press **-** to decrease delay time or speaker output levels.

25 SET MENU

Press this button to select functions in the SET MENU mode.

26 PROGRAM selector

Press **<** or **>** to select the DSP program. The name of the selected program appears on the display.

27 EFFECT

Switches on and off the output from the center and rear speakers so that the sound becomes normal 2-channel.

* Even if the output from the center and rear speakers is off, when the Dolby Digital is decoded, the signals at all channels are distributed to the main channels and output from the main speakers.

28 VIDEO AUX terminals

Connect an auxiliary video or audio input source unit such as a camcorder to these terminals. If the connected video unit has a S video output terminal, connect it to the **S VIDEO** terminal to obtain a high resolution picture. The source connected to these terminals can be selected by **INPUT**.

DISPLAY PANEL

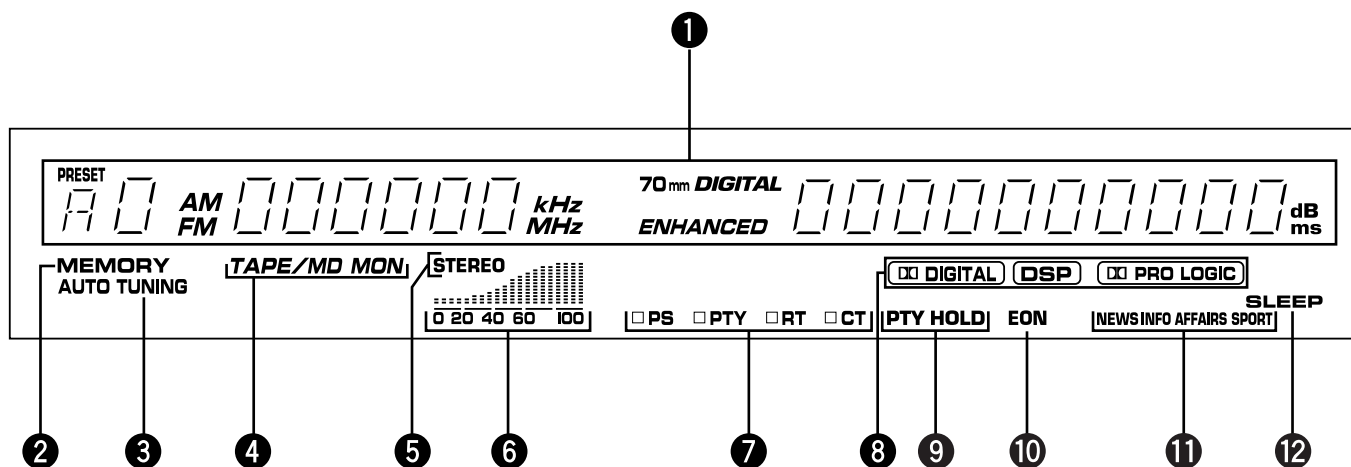

1 Multi-information display

Displays various information, for example station frequency, preset station number and name of selected input source.

2 MEMORY indicator

When **MEMORY** is pressed, this indicator flashes for about five seconds. During this period, the displayed station can be stored to the memory.

3 AUTO TUNING indicator

Lights up when this unit is in the automatic tuning mode.

4 TAPE/MD MON indicator

Lights up when the tape deck (or MD recorder etc.) is selected as the input source by pressing **TAPE/MD MON / EXT. DECODER** on the front panel or **TAPE/MD** on the remote control transmitter.

5 STEREO indicator

Lights up when an FM stereo broadcast with sufficient signal strength is received.

6 Signal-level meter

Indicates the signal level of the received station. If multipath interference is detected, the indication decreases.

7 RDS mode indicators

The name(s) of RDS mode(s) employed by the currently received RDS station light(s) up. Illumination of the indicator on the head of a name shows that the corresponding RDS mode is now selected.

8 DIGITAL, DSP and PRO LOGIC indicators

“**DIGITAL**” lights up when the built-in Dolby Digital decoder is on and the signals of selected source encoded with the Dolby Digital is not in 2-channel. “**DSP**” lights up when the built-in digital sound field processor is on, and “**PRO LOGIC**” lights up when the built-in Dolby Pro Logic Surround decoder is on. Depending on the selected DSP program, both “**DIGITAL**” and “**DSP**”, or both “**DSP**” and “**PRO LOGIC**” will light up.

9 PTY HOLD indicator

Lights up while the search is performed in the PTY SEEK mode.

10 EON indicator

Lights up when an RDS station that employs the EON data service is received.

11 Program type name indicators

The name selected in the EON mode lights up.

12 SLEEP indicator

Lights up while the built-in SLEEP timer is functioning.

SPEAKER SETUP

SPEAKERS TO BE USED

This unit is designed to provide the best sound-field quality with a 5-speaker configuration, using main speakers, rear speakers and a center speaker.

The main speakers are used for the main source sound plus the effect sounds. They will probably be the speakers from your present stereo system. The rear speakers are used for the effect and surround sounds, and the center speaker is for the center sounds (dialog, vocals, etc.). If for some reason it is not practical to use a center speaker, you can do without it. Best results, however, are obtained with the full system.

The main speakers should be high performance models and have enough power handling capacity to accept the maximum output of your audio system.

Other speakers do not have to be equal to the main speakers. For precise sound localization, however, it is ideal to use high performance models that can reproduce sounds in the full range for the center speaker and the rear speakers.

Use of a subwoofer expands your sound field

It is also possible to further expand your system with the addition of a subwoofer and amplifier. The use of a subwoofer is effective not only for reinforcing bass frequencies from any or all channels, but also for reproducing the LFE (low frequency effect) sound with high fidelity when playing back a source with the Dolby Digital decoded. You may wish to choose the convenience of a YAMAHA Active Servo Processing Subwoofer System, which has its own built-in power amplifier.

SPEAKER CONFIGURATION

5-Speaker Configuration

This configuration is the most effective and recommended one. When playing back a source using the DSP program, **DOLBY PRO LOGIC/DOLBY DIGITAL, DOLBY PRO LOGIC ENHANCED/DOLBY DIGITAL ENHANCED, 70 mm MOVIE THEATER/DIGITAL MOVIE THEATER, MONO MOVIE** or **TV SPORTS**, or when playing back a source which contains center-channel signals (dialog, vocals, etc.) using any DSP program with the Dolby Digital decoded, conversations will be output from the center speaker and the ambience will be excellent.

Note: Set the CNTR (CENTER SPEAKER) mode to the "LARGE" or "SMALL" position. (For details, see page 20.)

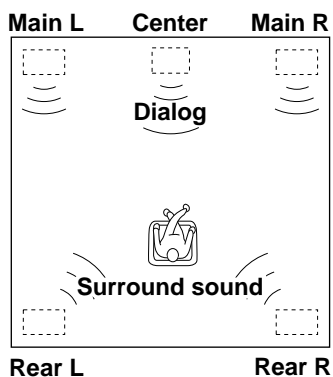

4-Speaker Configuration

The center speaker is not used in this configuration. When playing back a source using the DSP program, **DOLBY PRO LOGIC/DOLBY DIGITAL, DOLBY PRO LOGIC ENHANCED/DOLBY DIGITAL ENHANCED, 70 mm MOVIE THEATER/DIGITAL MOVIE THEATER, MONO MOVIE** or **TV SPORTS**, or when playing back a source which contains center-channel signals (dialog, vocals, etc.) using any DSP program with the Dolby Digital decoded, the center sound is output from the left and the right main speakers. However, the sound effect of other programs will be the same as that of the 5-speaker configuration.

Note: Be sure to set the CNTR (CENTER SPEAKER) mode to the "NONE" position. (For details, see page 20.)

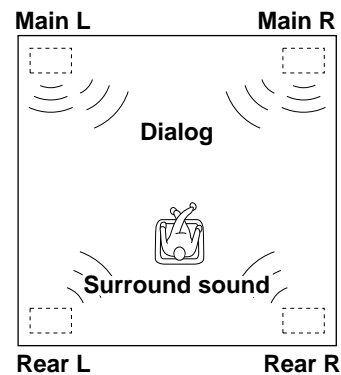

SPEAKER PLACEMENT

When you place the speakers, refer to the following diagram:

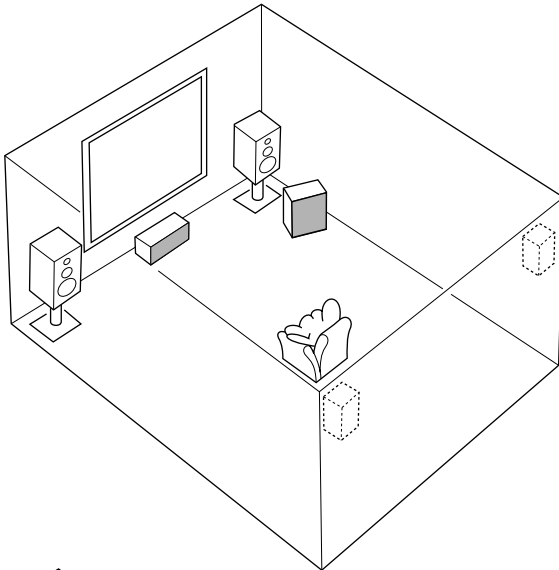

Main speaker



Center speaker



Rear speaker



Subwoofer

- Main:** The position of your present stereo speaker system.
- Rear:** Behind your listening position, facing slightly inward. Nearly 1.8 m (approx. 6 feet) up from the floor.
- Center:** Precisely between the main speakers. (To avoid interference with TV sets, use a magnetically shielded speaker.)
- Subwoofer:** The position of the subwoofer is not so critical because low bass tones are not highly directional.

CONNECTIONS

Never plug in this unit and other components until all connections are completed.

CONNECTIONS WITH OTHER COMPONENTS

When making connections between this unit and other components, be sure all connections are made correctly, that is to say L (left) to L, R (right) to R, "+" to "+" and "-" to "-". Also, refer to the owner's manual for each component to be connected to this unit.

* If you have YAMAHA components numbered as 1, 3, 4, etc. on the rear panel, connections can be made easily by making sure to connect the output (or input) terminals of each component to the same-numbered terminals of this unit.

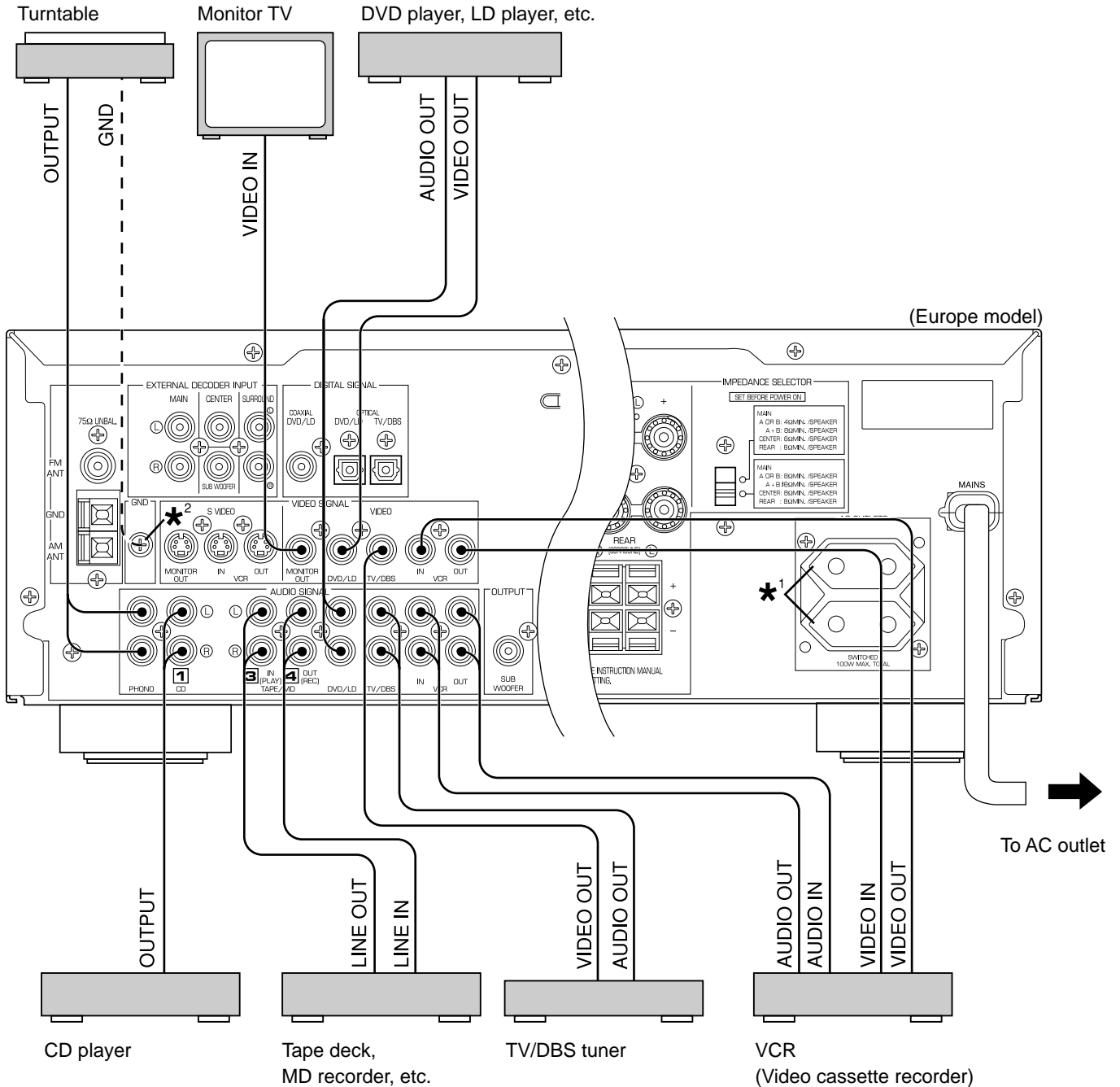

*¹, *²: See the next page.

***¹**
SWITCHED AC OUTLET(S)

(Europe model) 2 SWITCHED OUTLETS
 (U.K. model) 1 SWITCHED OUTLET

Use these to connect the power cords from your components to this unit.

The power to the **SWITCHED** outlets is controlled by this unit's **STANDBY/ON** or the provided remote control transmitter's **POWER** and **STANDBY**. These outlets will supply power to any component whenever this unit is turned on.

The maximum power (total power consumption of components) that can be connected to the **SWITCHED AC OUTLET(S)** is 100 watts.

***²**
GND terminal (For turntable use)

Connecting the ground wire of the turntable to the **GND** terminal will normally minimize hum, but in some cases better results may be obtained with the ground wire disconnected.

CONNECTING TO AN EXTERNAL DECODER

When using the DTS or other decoder with 6-channel discrete outputs, connect the **6CH DISCRETE OUTPUT** terminals of the decoder to the **EXTERNAL DECODER INPUT** terminals of this unit.

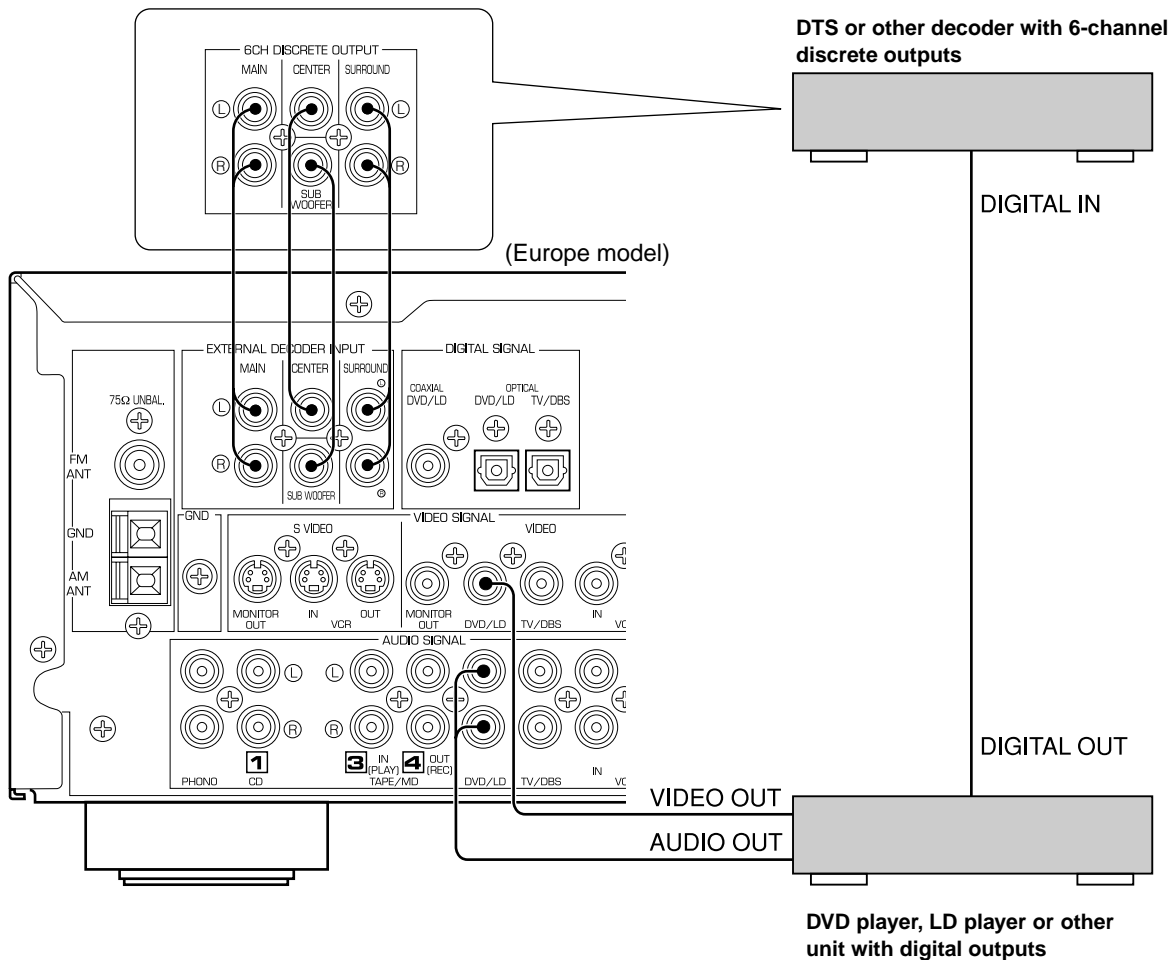

CONNECTING TO DIGITAL (COAXIAL AND/OR OPTICAL) TERMINALS

If your DVD (LD) player, TV/DBS tuner, etc. are equipped with coaxial or optical digital audio signal output terminals, they can be connected to this unit's **COAXIAL** and/or **OPTICAL** digital signal input terminals.

To make a connection between optical digital audio signal terminals, remove the cover from each terminal, and then connect them by using a commercially available optical fiber cable that conforms to EIAJ standards. Other cables might not function correctly.

Even if you connect an audio/video unit to the **COAXIAL** (or **OPTICAL**) terminal of this unit, you must keep the unit connected with the same named analog audio signal terminals of this unit, because digital signal cannot be recorded by a tape deck or VCR connected to this unit. You can switch the selection of input signals between "digital" and "analog" easily. (See page 27 for details.)

Notes

- When connecting an audio/video unit to both of the digital and analog terminals of this unit, make sure to connect to both terminals of the same name.
- Be sure to attach the covers when the **OPTICAL** terminals are not being used, in order to protect the terminals from dust.
- The input signal from the DVD/LD input terminals is selected in the following order of priority. (input mode: AUTO position)
 - 1 **COAXIAL** terminal
 - 2 **OPTICAL** terminal
 - 3 ANALOG terminal
- All digital audio signal input terminals are applicable to the sampling frequency of 32 kHz, 44.1 kHz and 48 kHz.

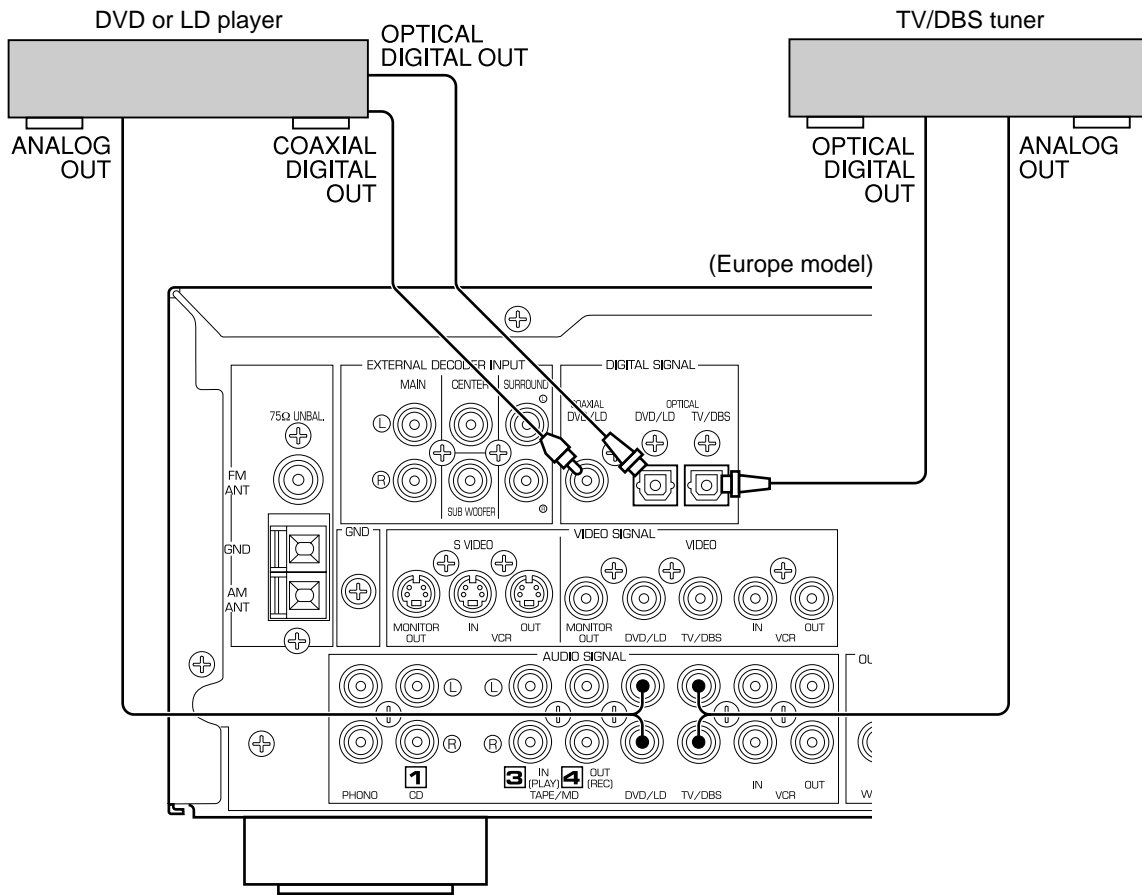

CONNECTING TO S VIDEO TERMINALS

If you have a VCR and a monitor equipped with “S” (high-resolution) video terminals, those terminals can be connected to this unit’s **S VIDEO** terminals. Connect the VCR’s “S” video input and output terminals to this unit’s **S VIDEO VCR OUT** and **IN** terminals respectively, and connect the monitor’s “S” video input terminal to this unit’s **S VIDEO MONITOR OUT** terminal. Otherwise, connect the VCR’s composite video terminals to this unit’s composite **VIDEO** terminals, and connect the monitor’s composite video input terminal to this unit’s composite **MONITOR OUT** terminal.

Note

If video signals are sent to both **S VIDEO** input and composite input terminals, the signals will be sent to their respective output terminals.

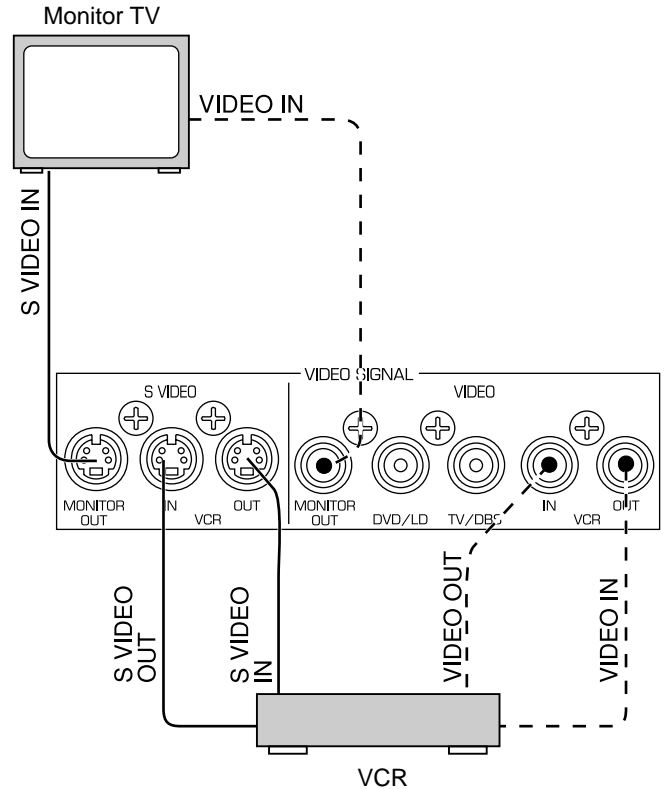

CONNECTING TO VIDEO AUX TERMINALS (ON THE FRONT PANEL)

These terminals are used to connect any video input source, such as a camcorder, to this unit.

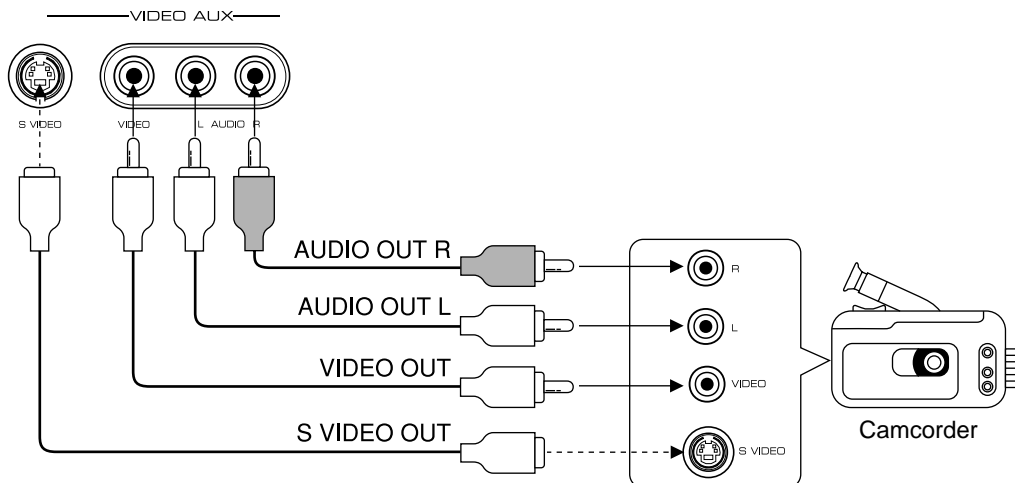

CONNECTING SPEAKERS

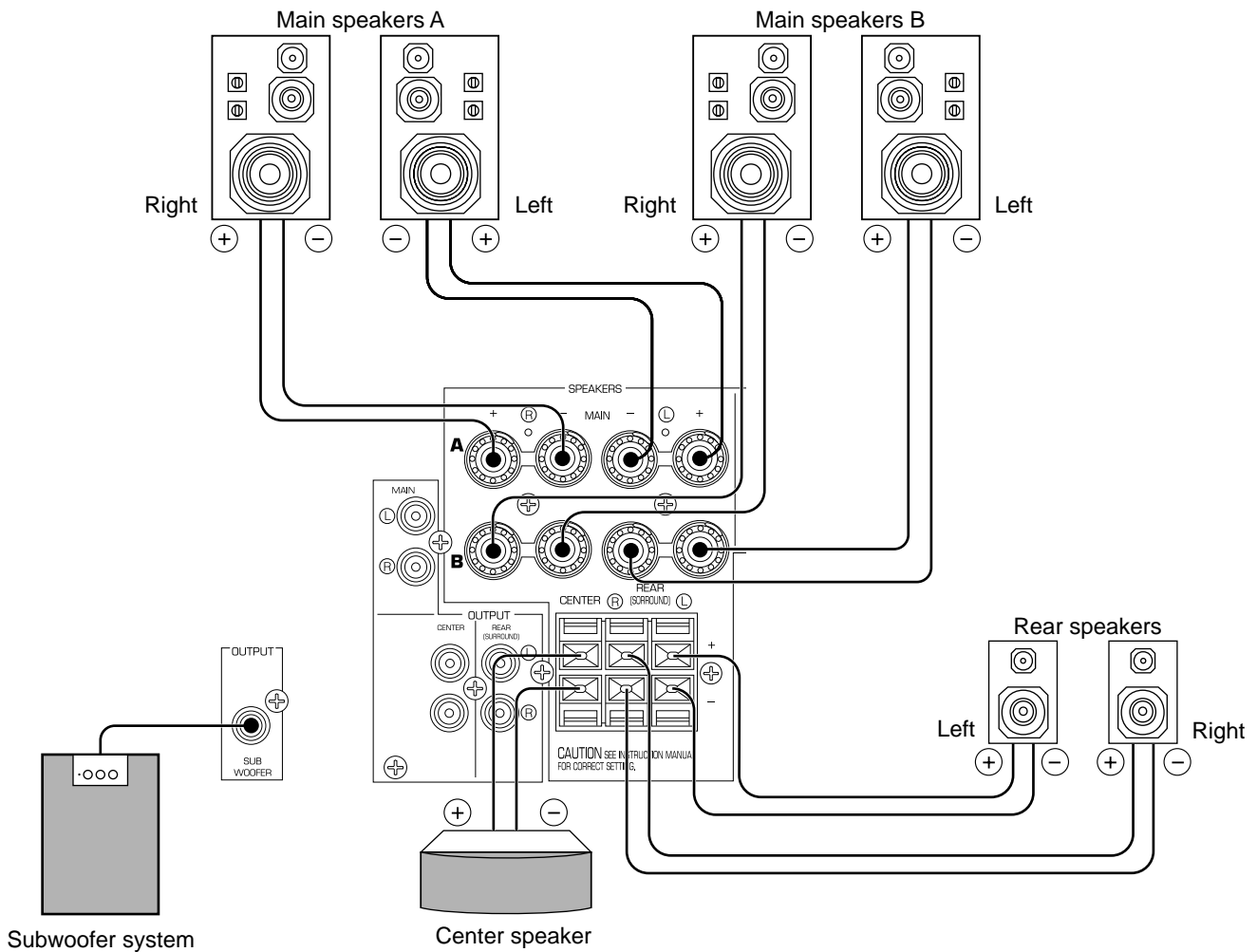

Note
Use speakers with the specified impedance shown on the rear panel of this unit.

Note on main speaker connections:
One or two speaker systems can be connected to this unit. If you use only one speaker system, connect it to either the **SPEAKERS A** or **B** terminals.

Note on a subwoofer connection:
You may wish to add a subwoofer to reinforce low frequencies or to output low bass sound from the subwoofer channel. If you have a subwoofer with built-in amplifier, including the YAMAHA Active Servo Processing Subwoofer System, connect the **SUBWOOFER OUTPUT** terminal of this unit to the input terminal of the subwoofer system. If you have an amplifier and a subwoofer, connect the **SUBWOOFER OUTPUT** terminal of this unit to the input terminal of the subwoofer amplifier, and then connect the speaker terminals of the subwoofer amplifier to the subwoofer.

Note on center speaker connection:
Center speaker can be connected to this unit. Place it on or under the TV.

How to connect

Connect the **SPEAKERS** terminals to your speakers with wire of the proper gauge, cut as short as possible. If the connections are faulty, no sound will be heard from the speakers. Make sure that the polarity of the speaker wires is correct, that is the + and – markings are observed. If these wires are reversed, the sound will be unnatural and lack bass.

Caution

Do not let the bare speaker wires touch each other and do not let them touch any metal part of this unit. This could damage this unit and/or speakers.

For connecting to the MAIN SPEAKERS terminals

Red: positive (+)
Black: negative (–)

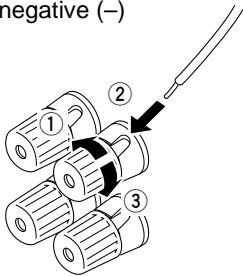

- ① Unscrew the knob.
- ② Insert the bare wire.
[Remove approx. 5 mm (1/4") insulation from the speaker wires.]
- ③ Tighten the knob and secure the wire.

For connecting to the REAR and CENTER SPEAKERS terminals

Red: positive (+)
Black: negative (–)

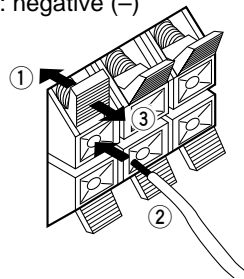

- ① Press the tab.
- ② Insert the bare wire.
[Remove approx. 5 mm (1/4") insulation from the speaker wires.]
- ③ Release the tab and secure the wire.

OUTPUT TERMINALS (FOR DRIVING SPEAKERS WITH EXTERNAL AMPLIFIERS)

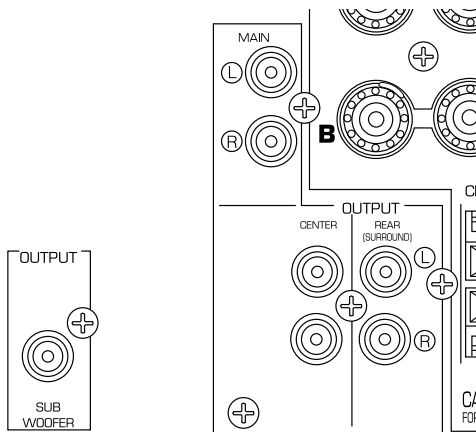

However, if you drive a center speaker with an external power amplifier, connect the input terminal of the external amplifier to this terminal.

If you are placing two center speakers on each side of the TV, use two amplifiers and connect each amplifier to one of the two **CENTER OUTPUT** terminals. Then connect the center speakers to the amplifiers.

REAR (SURROUND) OUTPUT terminals

These terminals are for the rear channel line output. There is no connection to these terminals when you use the built-in amplifier.

However, if you drive the rear speakers with an external stereo power amplifier, connect the input terminals of the external amplifier (MAIN IN or AUX terminals of a power amplifier or an integrated amplifier) to these terminals.

SUBWOOFER OUTPUT terminal

This terminal is for connecting to the input terminal of an amplifier for driving a subwoofer.

When the input signals to this unit are in normal 2-channel stereo, this terminal outputs only frequencies below 90 Hz from the main and center channels. When discrete signals are input to this unit and are selected as the input source, this terminal outputs signals from the subwoofer channel.

MAIN OUTPUT terminals

These terminals are for the main channel line output. There is no connection to these terminals when you use the built-in amplifier.

However, if you drive the main speakers with an external stereo power amplifier, connect the input terminals of the external amplifier (MAIN IN or AUX terminals of a power amplifier or an integrated amplifier) to these terminals.

* Output signals from the **MAIN OUTPUT** terminals are affected by the use of **BASS**, **TREBLE**, and **BALANCE**.

CENTER OUTPUT terminals

These terminals are for the center channel line output. There is no connection to these terminals when you use the built-in amplifier.

Note

Output levels of signals from all of these terminals are adjusted by the use of **VOLUME** on the front panel or **VOLUME** (^ v) on the remote control transmitter.

IMPEDANCE SELECTOR SWITCH

WARNING

Do not change the **IMPEDANCE SELECTOR** switch setting while the power of this unit is on, otherwise this unit may be damaged.

IF THIS UNIT FAILS TO TURN ON WHEN THE STANDBY/ON SWITCH IS PRESSED, the **IMPEDANCE SELECTOR** switch may not be fully set to either end. If so, set the switch to either end fully.

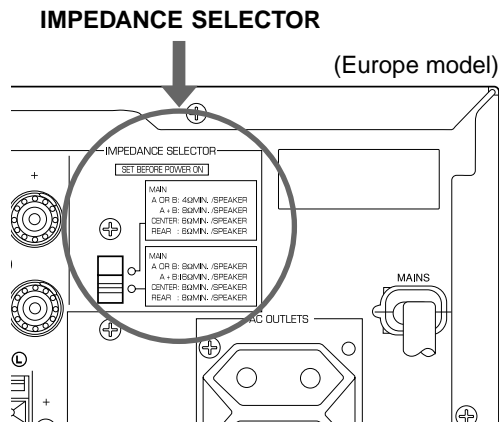

Select the position whose requirements your speaker system meets.

 (Upper position)

Main: If you use one pair of main speakers, the impedance of each speaker must be 4Ω or higher.
If you use two pairs of main speakers, the impedance of each speaker must be 8Ω or higher.

Center: The impedance of the speaker must be 6Ω or higher.

Rear: The impedance of each speaker must be 6Ω or higher.

 (Lower position)

Main: If you use one pair of main speakers, the impedance of each speaker must be 8Ω or higher.
If you use two pairs of main speakers, the impedance of each speaker must be 16Ω or higher.

Center: The impedance of the speaker must be 8Ω or higher.

Rear: The impedance of each speaker must be 8Ω or higher.

ANTENNA CONNECTIONS

Each antenna should be correctly connected to the designated terminals, referring to the following diagram. Both AM and FM indoor antennas are included with this unit. In general, these antennas will probably provide sufficient signal strength. Nevertheless, a properly installed outdoor antenna will give clearer reception than an indoor one. If you experience poor reception quality, an outdoor antenna may result in improvement.

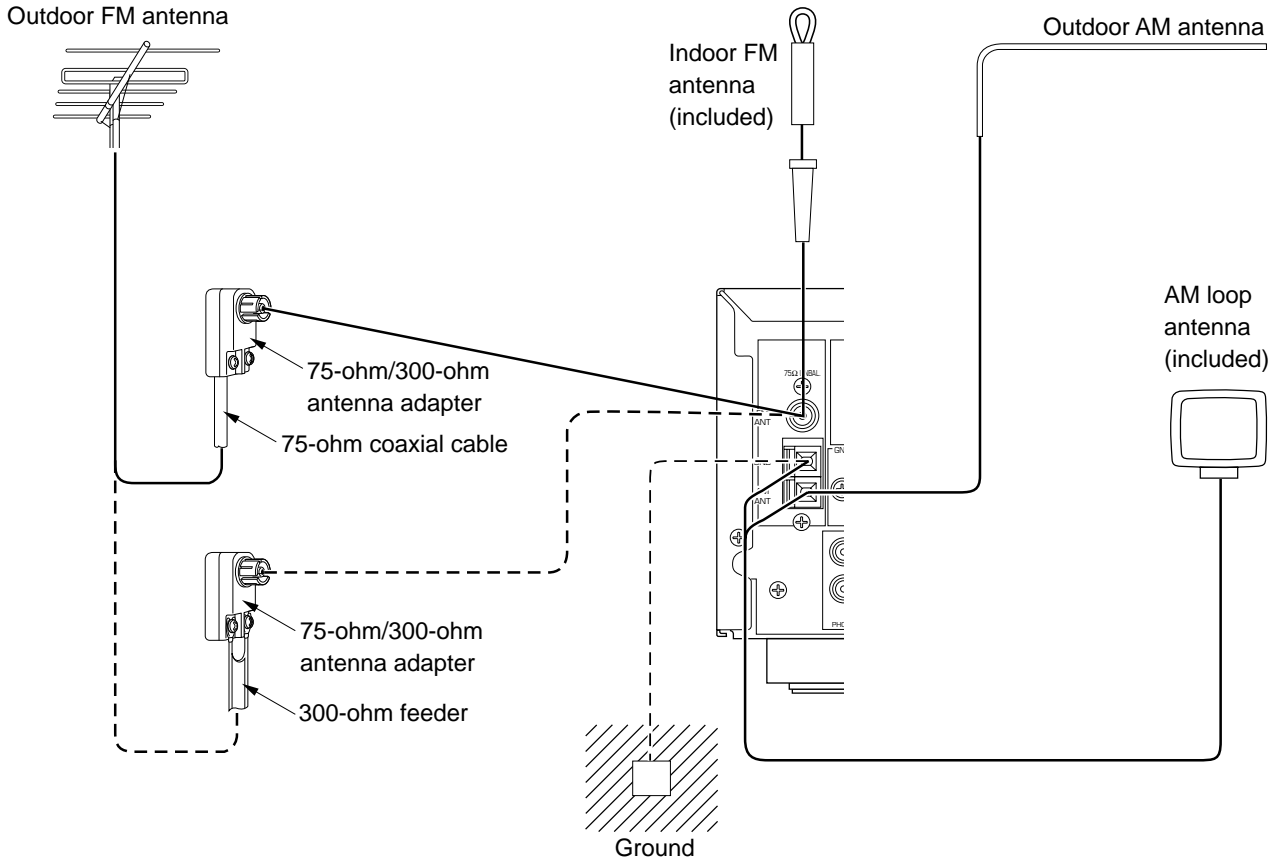

Connecting the AM loop antenna

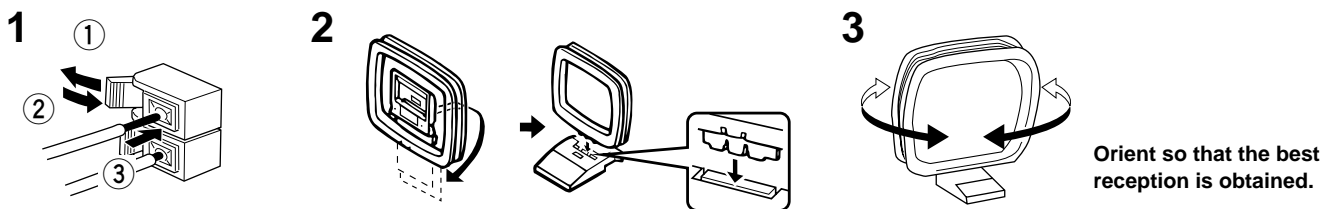

- * The AM loop antenna should be placed away from this unit. The antenna may be hung on a wall.
- * The AM loop antenna always should be connected, even if an outdoor AM antenna is connected to this unit.

GND TERMINAL

For maximum safety and minimum interference, connect the **GND** terminal to a good earth ground. A good earth ground is a metal stake driven into moist earth.

Notes

- When connecting the indoor FM antenna, insert its connector into the **FM ANT** terminal firmly.
- If you need an outdoor FM antenna to improve FM reception quality, either 300-ohm feeder or coaxial cable may be used. In locations troubled by electrical interference, coaxial cable is preferable.

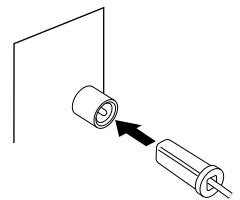

ADJUSTMENTS BEFORE USING THIS UNIT

SELECTING THE OUTPUT MODES

This unit provides you the following five functions to determine the method of distributing output signals to speakers suitable for your audio system. When speaker connections are all completed, select a proper position on each function to make the best use of your speaker system. (See "ADJUSTMENTS IN THE 'SET MENU' MODE" on page 46.)

- | | | |
|---------------------------------|-------------------------------|-------------------------------|
| 1. CNTR (CENTER SPEAKER) | 2. REAR (REAR SPEAKER) | 3. MAIN (MAIN SPEAKER) |
| 4. BASS (LFE/BASS OUT) | 5. M.LVL (MAIN LEVEL) | |

DESCRIPTION OF EACH FUNCTION

1. CNTR (CENTER SPEAKER)

Choices: LARGE/SMALL/NONE

Preset position: LARGE

LARGE: Select this position when your center speaker is approximately the same size as the main speakers.

SMALL: Select this position when you use a center speaker that is smaller than the main speakers.
In this position, low bass signals (below 90 Hz) at the center channel are output from the main speakers (or the **SUBWOOFER OUTPUT** terminal if the SMALL position is selected on "3. MAIN" and the SW position is selected on "4. BASS").

NONE: Select this position when you do not have a center speaker. The center channel sound will be output from the left and right main speakers.

2. REAR (REAR SPEAKER)

Choices: LARGE/SMALL

Preset position: LARGE

LARGE: Select this position if your rear speakers have a high ability for bass reproduction, or a subwoofer is connected to the rear speaker in parallel.

In this position, full range signals are output from the rear speakers.

SMALL: Select this position if your rear speakers do not have a high ability for bass reproduction.

In this position, low bass signals (below 90 Hz) at the rear channels are output from the **SUBWOOFER OUTPUT** terminal (or the main speakers if the MAIN position is selected on "4. BASS").

3. MAIN (MAIN SPEAKER)

Choices: LARGE/SMALL

Preset position: LARGE

LARGE: Select this position if your main speakers have a high ability for bass reproduction.
In this position, full range signals present at the main channels are output from the main speakers.

SMALL: Select this position if your main speakers do not have a high ability for bass reproduction. However, if your system does not include a subwoofer, do not select this position.

In this position, low bass signals (below 90 Hz) at the main channels are output from the **SUBWOOFER OUTPUT** terminal if the SW or BOTH position is selected on "4. BASS".

4. BASS (LFE/BASS OUT)

Choices: SW/MAIN/BOTH

Preset position: SW

MAIN: Select this position if your system does not include a subwoofer.

In this position, full range signals present at the main channels, signals from the LFE channel and other low bass signals that are selected on "1. CNTR" to "3. MAIN" to be distributed from other channels are output from the main speakers.

SW/BOTH: Select either the SW or BOTH position if your system includes a subwoofer.

In either position, signals at LFE channel and other low bass signals that are selected on "1. CNTR" to "3. MAIN" to be distributed from other channels are output from the **SUBWOOFER OUTPUT** terminal. When the LARGE position is selected on "3. MAIN", in the SW position, no signal is distributed from the main channels to the **SUBWOOFER OUTPUT** terminal, however in the BOTH position, low bass signals from the main channels are output to both of the main speakers and the **SUBWOOFER OUTPUT** terminal.

5. M.LVL (MAIN LEVEL)

Choices: NORMAL (NRML)/-10 dB

Preset position: NORMAL (NRML)

NORMAL (NRML):

Normally select this position.

-10 dB: Select this position if the sound output from the main speakers is too loud and cannot be balanced with the sound output from the center and rear speakers. In this position, the sound output from the main speakers is attenuated.

ADJUSTING METHOD

Operations should be made while watching the information on this unit's display.

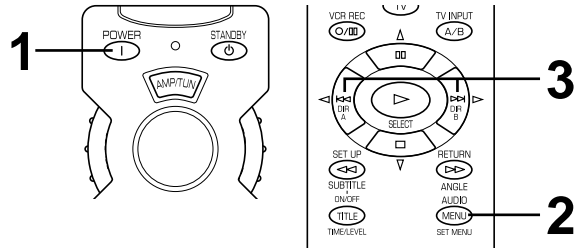
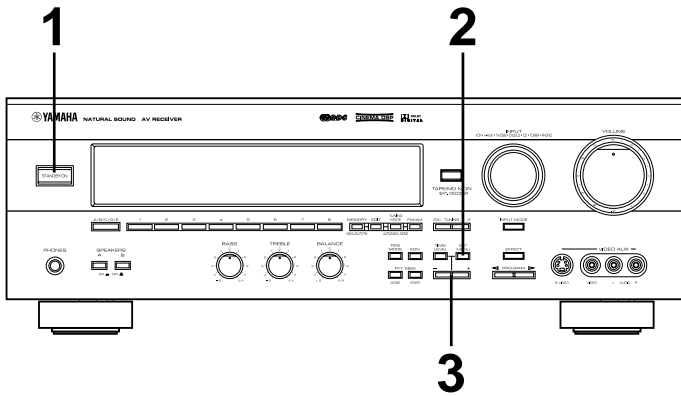

If you are using the remote control transmitter, set the **SELECTOR DIAL** to the AMP/TUN or DSP position on the remote control transmitter.

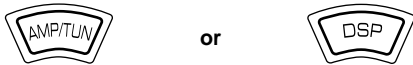

1 Turn the power on.

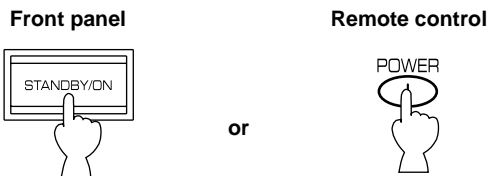

2 Press **SET MENU** once or more to select the title "1. CNTR" (so that "CNTR" appears on the display).

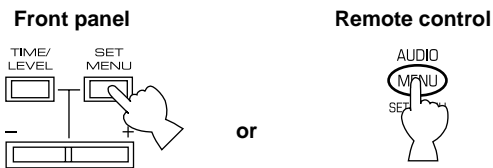

* After pressing **SET MENU** once on the remote control transmitter, you can also select the title by pressing ∇ . (Pressing Δ goes back one selection.)

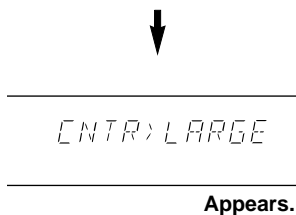

3 Press **+** or **-** once or more to select the position you want.

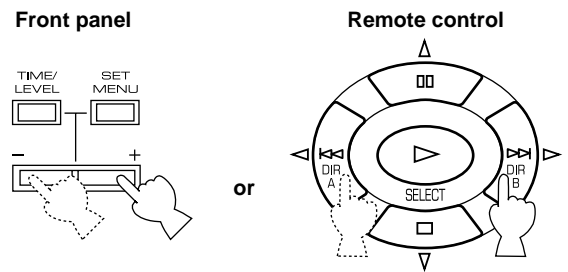

4 Repeat steps 2 and 3 to change selections on "2. REAR", "3. MAIN", "4. BASS" and/or "5. M.LVL" in the same way.

SPEAKER BALANCE ADJUSTMENT

This procedure lets you adjust the sound output level balance between the main, center and rear speakers using the built-in test tone generator. When this adjustment is performed, the sound output level heard at the listening position will be the same from each speaker. This is important for the best performance of the digital sound field processor, the Dolby Digital decoder and the Dolby Pro Logic Surround decoder.

The adjustment of each speaker output level should be done at your listening position with the remote control transmitter. After completing the adjustment of the output level for each speaker, use VOLUME (^ v) on the remote control transmitter at your listening position to check if the adjustments are satisfactory.

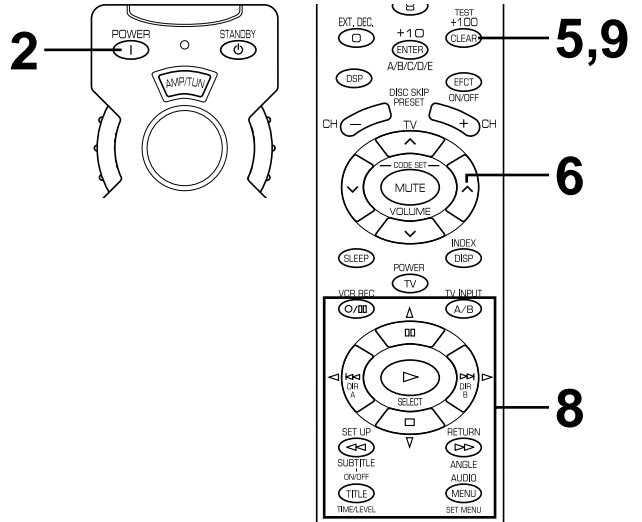
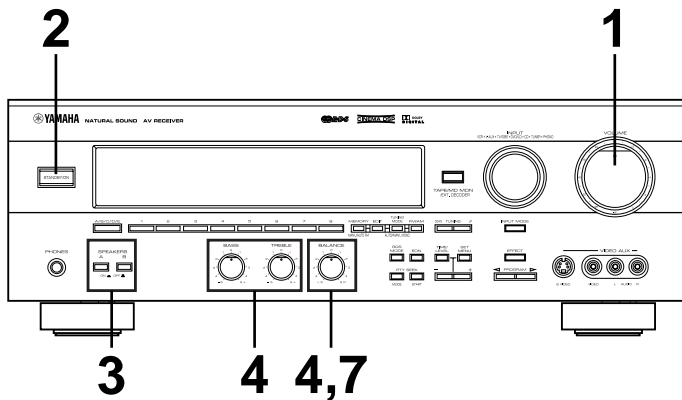

Set the **SELECTOR DIAL** to the AMP/TUN or DSP position on the remote control transmitter.

1 Set **VOLUME** to the “∞” position.

Front panel

2 Turn the power on.

Front panel **Remote control**

3 Select the main speakers to be used.

Front panel

* If you use two main speaker systems, press both **A** and **B**.

4 Set **BASS**, **TREBLE** and **BALANCE** to the "0" position.

Front panel

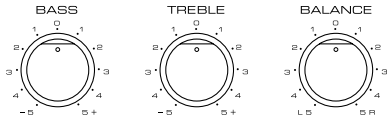

5 Press **TEST** (so that "TEST LEFT" appears on the display).

Remote control

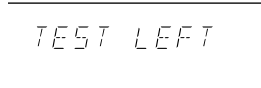

Appears.

6 Turn up the volume.

Remote control

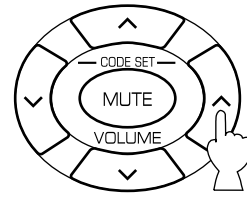

You will hear a test tone (like pink noise) from the left main speaker, then the center speaker, then the right main speaker, then the right rear speaker, and then the left rear speaker, for about two seconds each. The display changes as shown below.

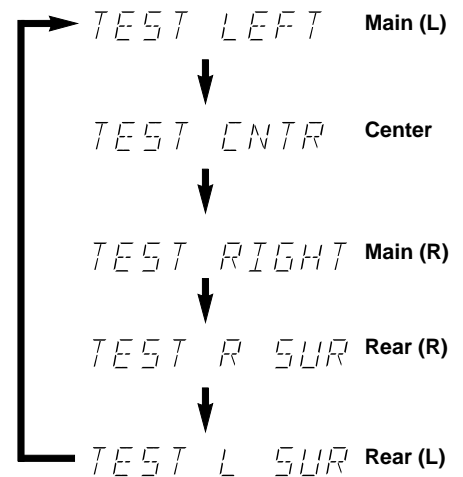

* If the function "1. CNTR" in the SET MENU mode is set to the NONE position, you will hear the center channel test tone from the left and right main speakers.

7 Adjust **BALANCE** so that the sound output level of the left main speaker and the right main speaker is the same.

Front panel

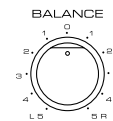

- 8** Adjust the sound output levels of the center speaker and the rear speakers so that they become almost as same as that of the main speakers.

Remote control



- a) Press Δ or ∇ once or more so that "CENTER", "R SUR." or "L SUR." appears on the display.
 * Select "CENTER" to adjust the output level of the center speaker and select "R SUR." or "L SUR." to adjust the output level of the rear speakers.

Remote control

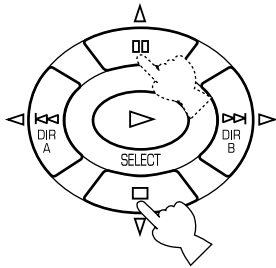

- b) Adjust the level.
 * Pressing \triangleright raises and \triangleleft lowers the level.
 * While adjusting, the test tone is fixed on the selected speaker.

Remote control

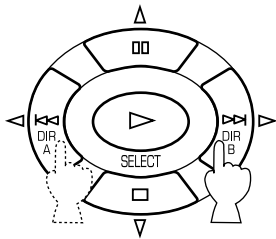

- 9** Press **TEST** once more to cancel the test tone.

Remote control



"TEST" disappears.

Notes

- Once you have completed these adjustments, you can adjust the overall sound level on your audio system by using **VOLUME** (or **VOLUME** (\wedge \vee) on the remote control transmitter) only.
- If you use external power amplifiers, you may also use their volume controls to achieve the proper balance.
- If the function "1. CNTR" in the SET MENU mode is set to the NONE position, the sound output level of the center speaker cannot be adjusted in step 8. The center sound is automatically output from the left and right main speakers.
- If there is insufficient sound output from the center and rear speakers, you may decrease the main speaker output level by setting "5. M.LVL" to "-10 dB".

BASIC OPERATIONS

TO PLAY A SOURCE

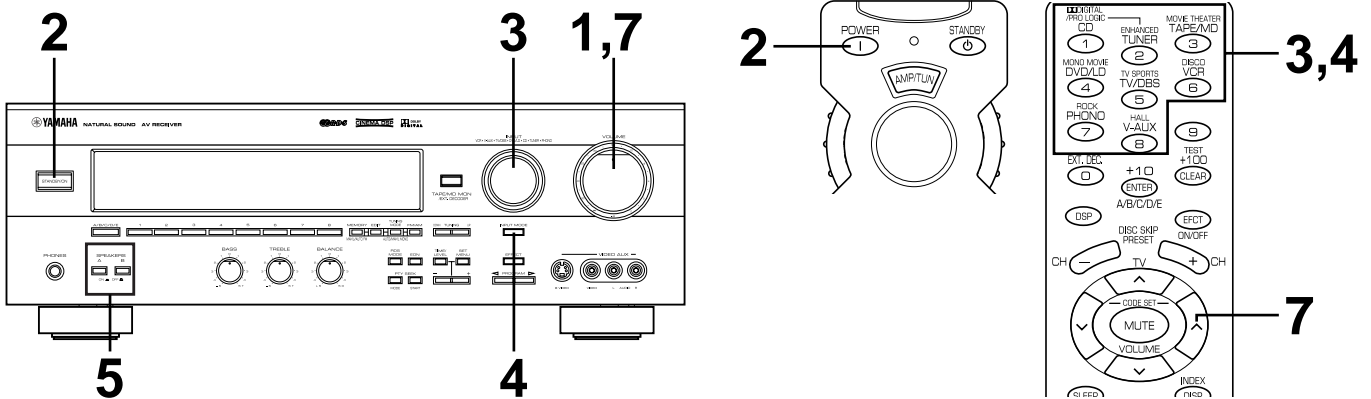

- Notes**
- Set the **SELECTOR DIAL** to the AMP/TUN position on the remote control transmitter.
 - To operate the CD player, DVD/LD player, tape deck, MD recorder, or other components using this remote control transmitter, set the **SELECTOR DIAL** to the component to be used. (See "SETUP CODES" on page 53.)

1 Set **VOLUME** to the "∞" position.

Front panel

2 Turn the power on.

Front panel

Remote control

or

3 Select the desired input source by using **INPUT**.
(For video sources, turn the TV/monitor ON.)
See page 27 if you are using an external decoder or playing a tape or an MD.

Front panel

Remote control

or

↓

The name of the selected input source will appear on the display.

- 4** For the DVD/LD or TV/DBS source, the current input mode is also shown.
- * To change the input mode for the DVD/LD or TV/DBS source, press **INPUT MODE** (or the button that you have pressed to select the input source in step 3 on the remote control transmitter) once or more until the desired input mode (AUTO or ANALOG) is shown on the display. (See page 27 for details on switching the input mode.)

Front panel

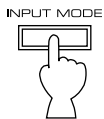

or

Remote control

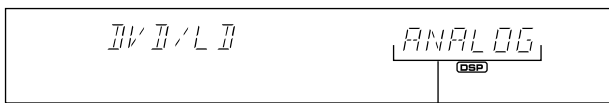
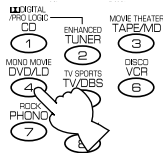

Input mode

- 5** Select the main speakers to be used.

Front panel

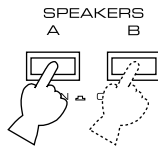

* If you use two main speaker systems, press both **A** and **B**.

- 6** Play the source. (For detailed information on tuning, see page 29.)

- 7** Adjust the volume to the desired output level.

Front panel

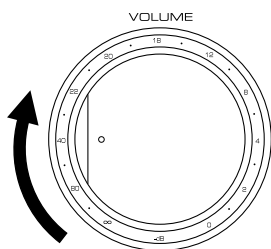

or

Remote control

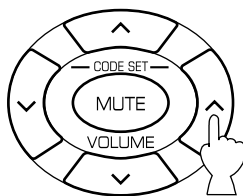

- 8** If desired, adjust **BASS**, **TREBLE**, **BALANCE**, etc. (see below) and use the digital sound field processor. (see page 40.)

Selecting the SPEAKER system

Because one or two speaker systems (as main speakers) can be connected to this unit, **SPEAKERS** allow you to select speaker system **A** or **B**, or both at once.

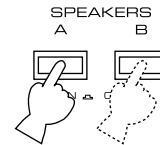

Adjusting the BALANCE control

Adjust the balance of the output volume from the left and right speakers to compensate for sound imbalances caused by speaker location or listening room conditions.

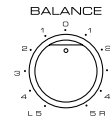

Note

This control is effective only for the sound from the main speakers.

Adjusting the BASS and TREBLE controls

BASS: Turn this clockwise to increase (or counter-clockwise to decrease) the low frequency response.

TREBLE: Turn this clockwise to increase (or counter-clockwise to decrease) the high frequency response.

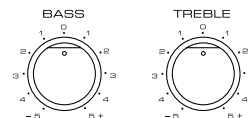

Note

These controls are effective only for the sound from the main speakers.

To play a tape or an MD

Press **TAPE/MD MON / EXT. DECODER** so that the “TAPE/MD MON” indicator lights up on the display, then play the tape or MD.

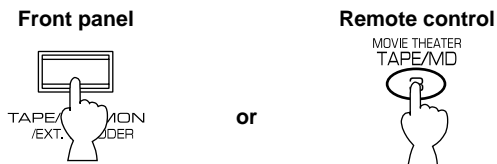

To stop playing the tape or MD, press **TAPE/MD MON / EXT. DECODER** twice so that the “TAPE/MD MON” indicator and “EXT. DECDR” disappear from the display and the play stops (or press **TAPE/MD** once on the remote control transmitter).

To use a decoder connected to the EXTERNAL DECODER INPUT terminals

Press **TAPE/MD MON / EXT. DECODER** once or more so that the “EXT. DECDR” appears on the display.

Start the play by operating the DTS or other external decoder, DVD player or LD player.

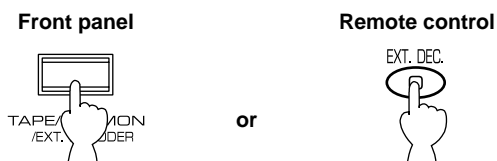

To stop playing, press **TAPE/MD MON / EXT. DECODER** once so that “EXT. DECDR” disappears from the display and the play stops (or press **EXT. DEC.** on the remote control transmitter).

When you finish using this unit

Press **STANDBY/ON** on the front panel again or **STANDBY** on the remote control transmitter to turn this unit into the standby mode.

Notes on using INPUT

- By using **INPUT**, you can select the program sources connected to the input terminals on the rear panel.
- To play a video source connected to the **VIDEO AUX** terminals on the front panel, set **INPUT** to the VIDEO AUX position.
- The audio source selected by **INPUT** will not be played if the “TAPE/MD MON” indicator lights up or if “EXT. DECDR” is displayed.
- If you select **INPUT** for a video source without canceling the selection of **TAPE/MD MON / EXT. DECODER** on the front panel (or, **TAPE/MD** or **EXT. DEC.** on the remote control transmitter), the playback result will be the video image from the video source and the sound from the input source selected by **TAPE/MD MON / EXT. DECODER** on the front panel (or, **TAPE/MD** or **EXT. DEC.** on the remote control transmitter).

- Once you play a video source, its video image will not be interrupted even if **INPUT** for an audio source is selected.
- When you select an input source by using **INPUT**, the DSP program (or no DSP program) that was used when the same input source was selected the last time, will be automatically recalled.

Switching the input mode (for DVD/LD and TV/DBS)

This unit allows you to switch the input mode only for sources connected to the DVD/LD and TV/DBS input terminals (on the rear panel of this unit) that input two or three types of signals.

The following two input modes are provided.

AUTO: For the source connected to the DVD/LD input terminals:

This mode is automatically selected when you turn the power of this unit on. In this mode, input signal is automatically selected in the following order of priority.

1. Digital input signal from the **COAXIAL** terminal
2. Digital input signal from the **OPTICAL** terminal
3. Analog input signal

For the source connected to the TV/DBS input terminals:

This mode is selected when you turn the power of this unit on if the AUTO position is selected on “10. INPUT” in the SET MENU mode. (For details, see page 47.) In this mode, input signal is automatically selected in the following order of priority.

1. Digital input signal from the **OPTICAL** terminal
2. Analog input signal

ANALOG:

In this mode, only analog input signal is selected even if a digital signal is input at the same time.

Select this mode when you want to use the analog input signal instead of the digital input signal.

Notes on input mode selection

- To playback a source with the Dolby Digital-decoded, set the input mode to AUTO.
- For the TV/DBS source only, the input mode selected on the function “10. INPUT” in the SET MENU mode is effective when you turn the power of this unit on.
- When you want to enjoy a source which has normal 2-channel signals with a Dolby Pro Logic Surround program, select the ANALOG mode.
- In the AUTO mode, there may be a case depending on some LD players or DVD players that when you make a search on a source encoded with the Dolby Digital during the play and then the play is restored, sound output is interrupted for a moment because the digital input signal is selected again.

TO RECORD A SOURCE TO TAPE OR MD

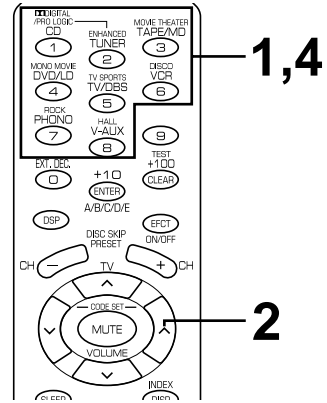
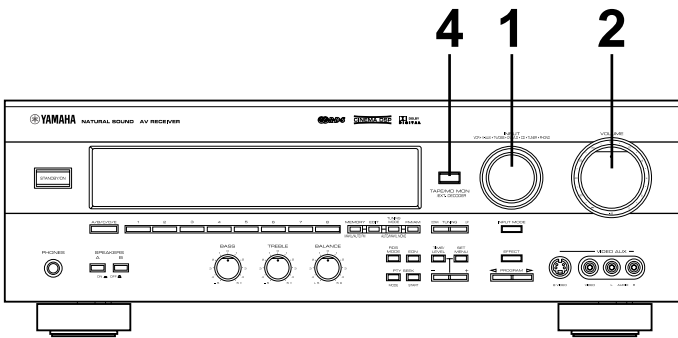

1 Select the source to be recorded.

Front panel

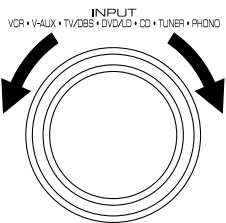

Remote control

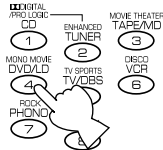

or

4 When the tape deck or MD recorder is used for recording, you can monitor the sounds being recorded by pressing **TAPE/MD MON / EXT. DECODER** so that the "TAPE/MD MON" indicator lights up on the display.

Front panel

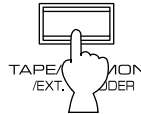

Remote control



or

2 Play the source and then turn **VOLUME** up to confirm the input source. (For detailed information on tuning, see page 29.)

Front panel

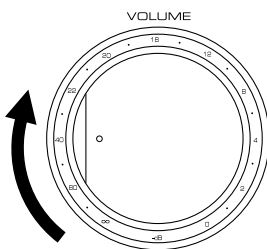

Remote control

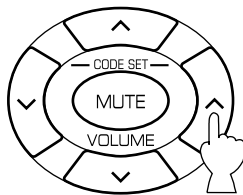

or

3 Begin recording on the tape deck, MD recorder or VCR connected to this unit.

Notes

- The settings of DSP and **VOLUME, BASS, TREBLE** and **BALANCE** have no effect on the material being recorded.
- Composite video and S video signals pass independently through this unit's video circuits. Therefore, when recording or dubbing video signals, if your video source unit is connected to provide only an S video (or only a composite video) signal, you can record only an S video (or only a composite video) signal on your VCR.
- A source that is connected to this unit through digital terminals only cannot be recorded by a tape deck or VCR connected to this unit.
- Please check the copyright laws in your country to record from records, compact discs, radio, etc. Recording of copyright material may infringe copyright laws.

If you watch a video software that uses scrambled or encoded signals to prevent it from being dubbed, there may be a case that the picture itself will be affected by those signals.

TUNING OPERATIONS

Set the **SELECTOR DIAL** to the AMP/TUN position on the remote control transmitter and select the tuner by using **INPUT**. Normally, if station signals are strong and there is no interference, quick automatic-search tuning (AUTOMATIC TUNING) is possible. However, if the signal from the station you want to select is weak, you must tune in to it manually (MANUAL TUNING).

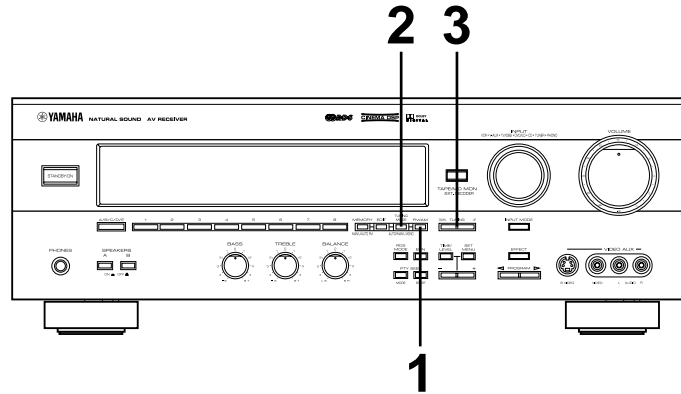

AUTOMATIC TUNING

- 1 Select the reception band (FM or AM) confirming it on the display.

Front panel

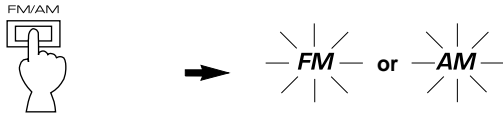

- 2 Press **TUNING MODE** (so that the "AUTO TUNING" indicator lights up on the display).

Front panel

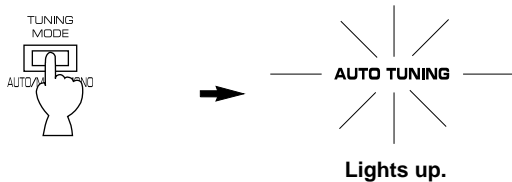

- 3 To tune in to a higher frequency, press the UP side of **TUNING** once.
To tune in to a lower frequency, press the DOWN side of **TUNING** once.

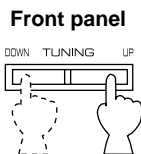

- * If the station where the tuning search stops is not the desired one, press once more.
- * If the tuning search does not stop at the desired station (because the signal from the station is weak), operate the manual tuning procedure.

MANUAL TUNING

- 1 Select the reception band (FM or AM) confirming it on the display.

Front panel

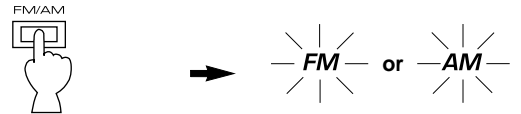

- 2 Press **TUNING MODE**.

Front panel



- 3 Tune in to the desired station manually.

Front panel

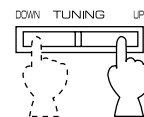

- * To continue the tuning search, press and hold the button.

Notes

- If you tune in to an FM station manually, it is received in monaural mode automatically to increase the signal quality.
- If an RDS station that employs PS data service is received, the station name is shown on the display.

MANUAL PRESET TUNING

This unit can store station frequencies selected by tuning. With this function, you can recall any desired station simply by selecting the preset station number with which it was stored. Up to 40 stations (8 stations x 5 groups) can be stored.

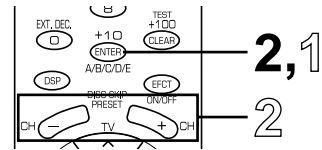
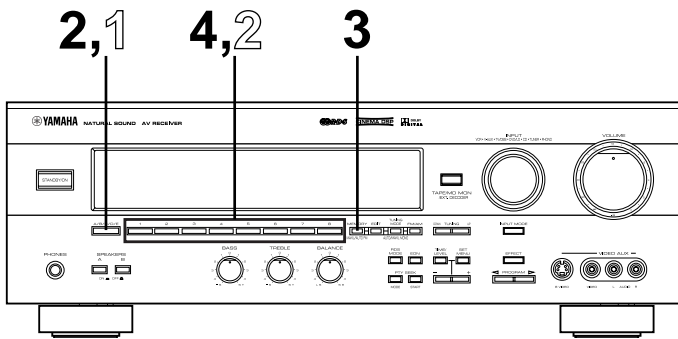

To store stations

- 1 Tune in to the desired station.
(See the previous page for tuning procedure.)

- 2 Press **A/B/C/D/E** once or more to select the desired group (A to E) of preset stations confirming it on the display.

Front panel

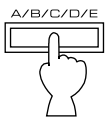

Remote control



or

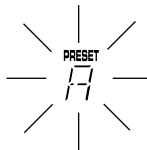

- 3 Press **MEMORY** (so that the "MEMORY" indicator flashes for about five seconds).

Front panel

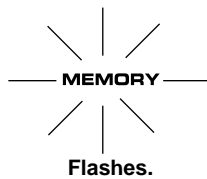

- 4 Select the preset station number with which you want to store the station before the "MEMORY" indicator goes off from the display.

Front panel

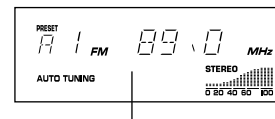
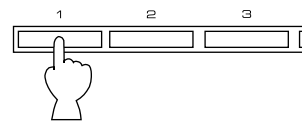

The displayed station has been stored to A1.

- * In the same way, store other stations to A2, A3 ... A8.
- * You can store more stations to preset station numbers in other groups in the same way by selecting other groups in step 2.

To recall a preset station

(See the illustration on previous page.)

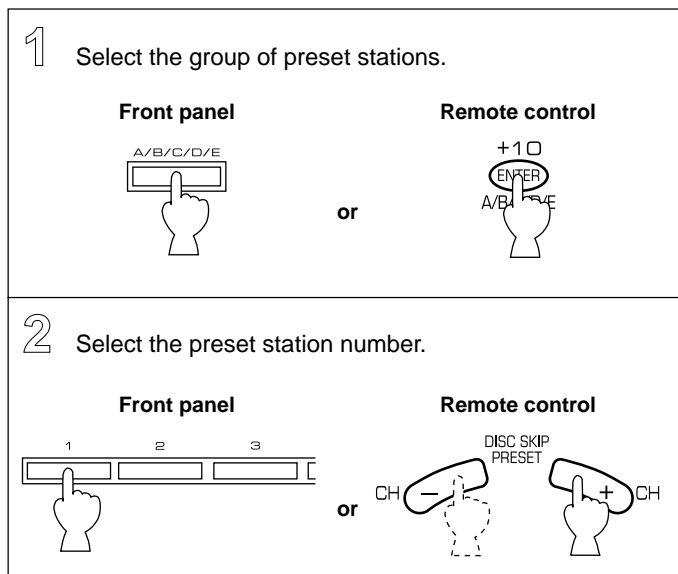

Notes

- A new setting can be stored in place of the former one.
- For presets, the setting of the reception mode (stereo or monaural) is stored along with the station frequency.

Memory back-up

The memory back-up circuit prevents the stored data from being lost even if this unit is turned into the standby mode, or the power plug is disconnected from the AC outlet, or the power is cut due to temporary power failure. If, however, the power is cut for more than one week, the memory may be erased. If so, it can be re-stored by simply following the preset tuning procedures.

AUTOMATIC PRESET TUNING (For RDS stations only)

You can also make use of an automatic preset tuning function for RDS stations only. Using this function, this unit performs automatic tuning and sequentially stores RDS stations with strong signals. Up to 40 stations are stored automatically in the same way as in the manual preset tuning method on page 30. Note that a new setting can be stored in place of the former one.

* See pages 34 to 38 for details on RDS stations.

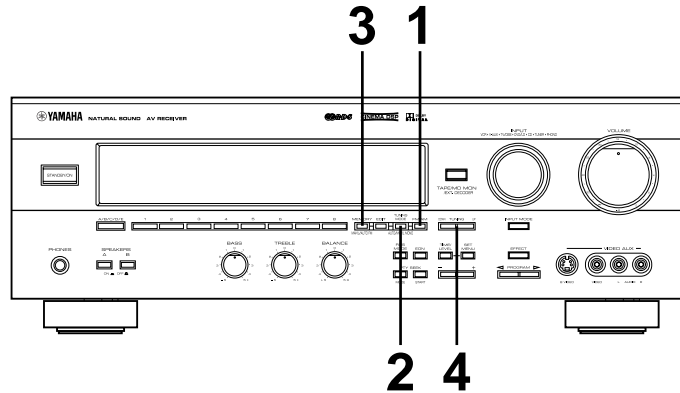

To store stations

- 1** Select the FM.

Front panel



- 2** Press **TUNING MODE** (so that the “AUTO TUNING” indicator lights up on the display).

Front panel

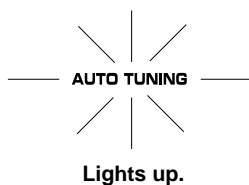
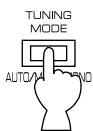

- 3** Press **MEMORY** and hold for about three seconds.

Front panel

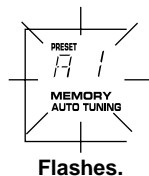

- 4** To tune in to higher frequencies, press the UP side of **TUNING** once.
To tune in to lower frequencies, press the DOWN side of **TUNING** once.

Front panel

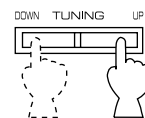

* If **TUNING** is not pressed, in a while, the automatic preset tuning begins automatically toward higher frequencies.

The automatic preset tuning begins from the frequency currently displayed. Received stations are stored to A1, A2 ... A8 sequentially.

* If more than 8 stations are received, they are also stored to the preset station numbers in other groups (B, C, D and E) in that order.

If you want to store the first station received by the automatic preset tuning to a desired preset station number.

For example, if you want to store the first received station to C5, select “C5” while “A1”, the “MEMORY” indicator and the “AUTO TUNING” indicator flash after pressing **MEMORY** in step 3. Then press **TUNING**. The first received station is stored to C5, and next stations to C6, C7 ... sequentially.

If stations are stored up to E8, automatic preset tuning stops automatically.

When automatic preset tuning is finished

The display shows the frequency of the last preset station. Check the contents and the number of preset stations by following the procedures in the section “To recall a preset station” on page 31.

Notes

- You can replace a preset station with another FM or AM station manually by simply following the procedures in the section "To store stations" on page 30.
- The automatic preset tuning search will be performed through all RDS network frequencies until stations are stored up to E8. Even if the number of received stations is not enough to be stored up to E8, the search is finished automatically after searching all frequencies.
- With this function, only RDS stations with sufficient signal strength are stored automatically. If the station you want to store is weak in signal strength, tune in to it in monaural manually and store it by following the procedures in the section "To store stations" on page 30.
 - * There may be a case that this function cannot receive a station which could be received by the automatic tuning method. This is because this function receives a large volume of PI (Program Identification) data along with the station.

EXCHANGING PRESET STATIONS

You can exchange the places of two preset stations with each other as shown below.

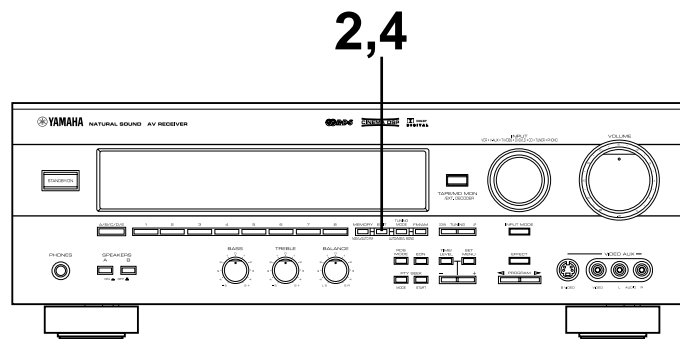

Example

If you want to shift the preset station on E1 to A5, and vice versa.

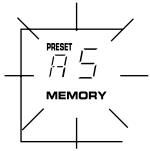
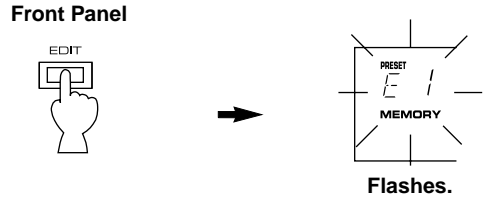
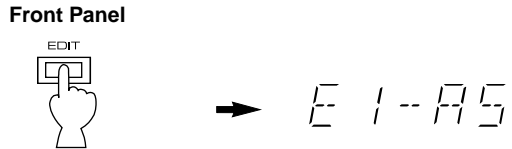
<p>1 Recall the preset station on E1 (by following the procedures in the section "To recall a preset station" on page 31).</p>	<p>3 Next, recall the preset station on A5 by following the same procedures as in step 1.</p>  <p>Flashes.</p>
<p>2 Press EDIT.</p>  <p>Flashes.</p>	<p>4 Press EDIT once more.</p>  <p>Shows the exchange of stations is completed.</p>

In areas where RDS broadcasts cannot be received, the RDS broadcast functions do not operate. (In such case, the procedures from pages 34 to 38 are not necessary.)

RECEIVING RDS STATIONS

RDS (Radio Data System) is a data transmission system gradually being introduced by FM stations in many countries. Stations using this system transmit an inaudible stream of data in addition to the normal radio signal.

RDS data contains various information, such as PI (Program Identification), PS (Program Service name), PTY (Program Type), RT (Radio Text), CT (Clock Time), EON (Enhanced Other Networks), etc.

RDS function is used by network stations.

DESCRIPTION OF RDS DATA

This unit can receive PI, PS, PTY, RT, CT, and EON when receiving RDS broadcast stations.

PS (Program Service name) mode:

The name of the RDS station now being received is displayed.

PTY (Program Type) mode:

The type of the program on the RDS station now being received is displayed. There are 15 program types to classify RDS stations. You can make this unit search for a station which is broadcasting a program of your desired program type. For details, see page 36.

RT (Radio Text) mode:

Information about the program (such as title of the song, name of the singer, etc.) on the RDS station now being received is displayed using a maximum of 64 alphabetical characters, including umlaut sign. If other characters are used on the RT data, they are displayed with under-bars.

CT (Clock Time) mode:

Current time is displayed in the following form. The CT data from the station being received changes every minute.

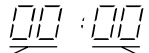

Hour Minute

If the data is accidentally cut off, "CT WAIT" may appear.

EON (Enhanced Other Networks):

See page 38.

CHANGING THE RDS MODES

When an RDS station is received, PS, PTY, RT and/or CT that correspond to the RDS data services employed by the station light up on the display. By pressing **RDS MODE**, you can change the display mode among the RDS modes employed by the received station in the order shown below. Illumination of the RDS modes indicator shows that the corresponding RDS mode is now selected.

- * When an RDS station is received, do not press **RDS MODE** until one or some names of RDS modes light up on the display. If the button is pressed before one or some names light up on the display, the mode cannot be changed. This is because the unit has not received all of the RDS data on the station yet.
- * If no RDS mode lights up on the display, the mode cannot be changed.
- * An RDS mode not employed by the station cannot be selected.

Front panel

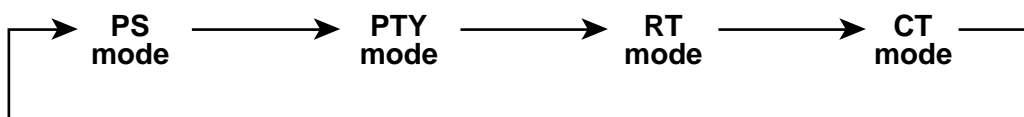

Notes

- RDS data service cannot be utilized by this unit if the received signal is not strong enough. Especially, the RT (Radio Text mode) requires a large amount of data to be received, so it is possible that the RT mode cannot be displayed even if other RDS modes (PS, PTY, etc.) are displayed.
- There may be a case that RDS data reception is not possible due to poor reception conditions. If so, press **TUNING MODE** so that the "AUTO TUNING" indicator goes off from the display. Though the reception mode is changed to monaural by this operation, when you change the display to an RDS mode, RDS data may be displayed.
- If the signal strength is weakened by external interference during reception of an RDS station, the RDS data service may be cut off suddenly and "...WAIT" will appear on the display.

PTY SEEK

By designating a program type, the unit automatically searches all preset RDS stations that is broadcasting a program of that type.

* There are 15 program types to classify RDS stations. For details, see page 37.

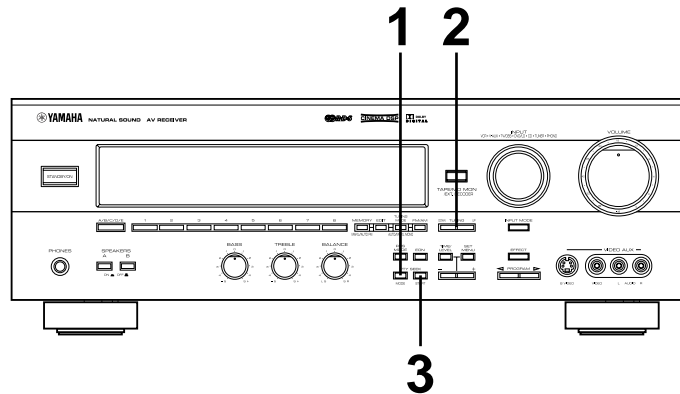

- 1** Press **PTY SEEK MODE** to turn the unit into the PTY SEEK mode.

Front panel

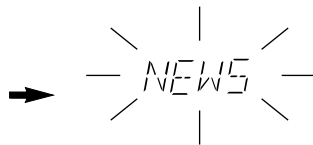
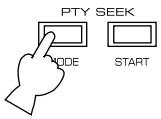

The program type of the station now being received or "NEWS" flashes on the display.

- 2** Press **TUNING** (UP side or DOWN side) to select the desired program type.

Front panel

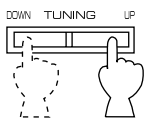

- 3** Press **PTY SEEK START** to begin searching all preset RDS stations.

Front panel

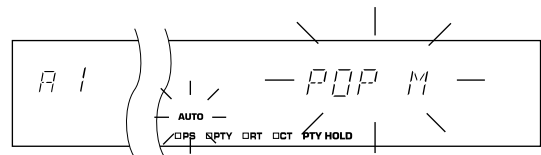
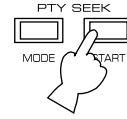

Flashes.

- * The "PTY HOLD" indicator lights up on the display.
- * If the station that is broadcasting a program of the program type is found, the unit stops at the station and displays the frequency of the station.
- * If the called station is not the desired one, press **PTY SEEK START** once more. The unit begins searching for another station that is broadcasting a program of the same program type.

To cancel this function

Press **PTY SEEK MODE** twice.

PROGRAM TYPES IN THE PTY MODE

NEWS	<p>News: Short accounts of facts, events and publicly expressed views, reportage and actuality.</p>	POP M	<p>Pop: Commercial music, which would generally be considered to be of current popular appeal, often featuring in current or recent record sales charts.</p>
AFFAIRS	<p>Current affairs: Topical program expanding or enlarging upon the news, generally in different presentation style or concept, including documentary debate, or analysis.</p>	ROCK M	<p>Rock: Contemporary modern music, usually written and performed by young musicians.</p>
INFO	<p>Information: Program whose purpose is to impart advice in the widest sense, including meteorological reports and forecasts, consumer affairs, medical help, etc.</p>	M.O.R. M	<p>M.O.R.: (Middle of the Road Music). Common term to describe music considered to be "easy-listening", as opposed to Pop, Rock or Classical. Music in this category is often but not always, vocal, and usually of short duration (<5 min.)</p>
SPORT	<p>Sport: Program concerned with any aspect of sport.</p>	LIGHT M	<p>Light classics: Classical Musical for general, rather than specialist appreciation. Examples of music in this category are instrumental music, and vocal or choral works.</p>
EDUCATE	<p>Education: Program intended primarily to educate, of which the formal element is fundamental.</p>	CLASSICS	<p>Serious classics: Performances of major orchestral works, symphonies, chamber music etc., and including Grand Opera.</p>
DRAMA	<p>Drama: All radio plays and serials.</p>	OTHER M	<p>Other music: Musical styles not fitting into any of the above categories. Particularly used for specialist music, of which Jazz, Rhythm & Blues, Folk, Country, and Reggae are examples.</p>
CULTURE	<p>Culture: Programs concerned with any aspect of national or regional culture, including religious affairs, philosophy, social science, language, theatre, etc.</p>		
SCIENCE	<p>Science: Programs about the natural sciences and technology.</p>		
VARIED	<p>Varied: Used for mainly speech-based programs usually of light-entertainment nature, not covered by above categories. Examples are: quizzes, panel games, personality interviews, comedy and satire.</p>		

EON FUNCTION

This function uses the EON (Enhanced Other Networks) data service on the RDS station network.

By simply selecting a desired program type (NEWS, INFO, AFFAIRS or SPORT), the unit will automatically monitor all preset RDS stations that broadcasts a program of that type and switch (from the program currently received) to that program when the broadcast starts.

* This function can be used only when an RDS station that employs the EON data service is received. (When such a station is received, the "EON" indicator lights up on the display.)

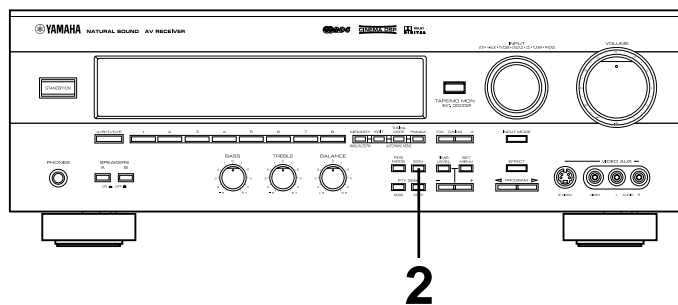

- 1 Make sure that the "EON" indicator lights up on the display.

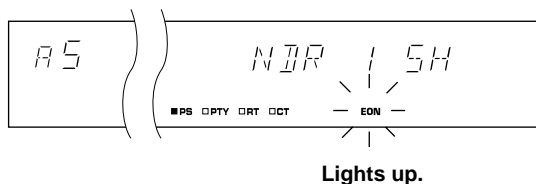

* If the "EON" indicator does not light up on the display, tune in to another RDS station so that the "EON" indicator lights up on the display.

- 3 When the broadcast of the called program ends, the previously received program (or another program on the same station) is recalled.

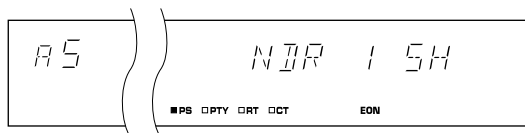

To cancel this function

Press **EON** once or more so that no program type name lights up on the display.

- 2 Press **EON** once or more to select a desired program type, NEWS, INFO, AFFAIRS or SPORT.

Front panel

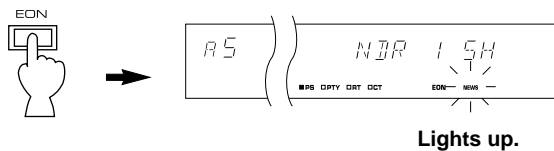

If a preset RDS program of a designated type starts broadcasting, the unit will automatically switch (from the program currently received) to that program.

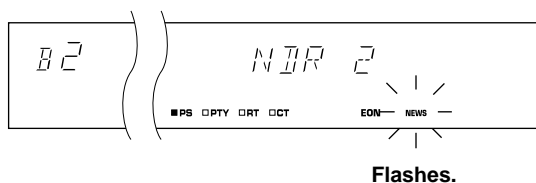

SETTING THE SLEEP TIMER

If you use the SLEEP timer of this unit, you can make this unit automatically switch to the standby mode. When you are going to sleep while enjoying a broadcast or other desired input source, this timer function is useful. The SLEEP timer can be controlled only with the remote control transmitter.

Notes

- To set the SLEEP timer for this unit, set the **SELECTOR DIAL** to a position other than the TV position. To set the SLEEP timer for your TV, set the **SELECTOR DIAL** to the TV position.
- The components on which the SLEEP timer is effective are the sources connected to the **SWITCHED AC OUTLET(S)** on the rear panel of this unit.

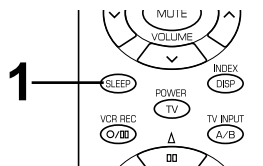

To set the SLEEP time

- 1 Press **SLEEP** once or more to select the desired SLEEP time.

Remote control



Indicates the SLEEP time.

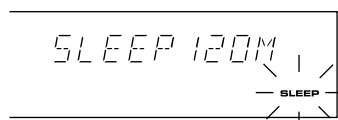

Flashes.

Whenever **SLEEP** is pressed, the SLEEP time will change as follows.

(Minutes)

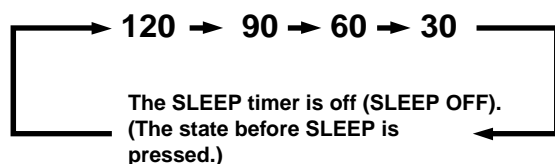

After a while, the "SLEEP" indicator lights up and the display returns to the indication before the SLEEP timer was set.

- 2 The unit will be switched to the standby mode automatically at the selected SLEEP time.

To cancel the selected SLEEP time

Remote control



Press **SLEEP** once or more so that "SLEEP OFF" appears on the display. (It will soon disappear and the "SLEEP" indicator will go off from the display.)

Note

The SLEEP timer setting can also be canceled by tuning this unit into the standby mode with **STANDBY/ON** on the front panel (or **STANDBY** on the remote control transmitter) or disconnecting the power plug of this unit from the AC outlet.

USING DIGITAL SOUND FIELD PROCESSOR (DSP)







This unit incorporates a sophisticated, multi-program digital sound field processor. The processor allows you to electronically expand and change the shape of the audio sound field from both audio and video sources, creating a theater-like experience in your listening room. You can create an excellent audio sound field by selecting a suitable sound field program (this will, of course, depend on what you are listening to), and adding any desired adjustments.

The following list gives you a brief description of the sound fields produced by each of the DSP programs. Keep in mind that most of these are precise digital recreations of actual acoustic environments. The data for these sound fields was recorded at actual locations using sophisticated sound field measurement equipment.

Note

The channel level balance between the left and right rear speakers may vary depending on the sound field you are listening to. This is due to the fact that most of these sound field are re-creation of actual acoustic environments.

BRIEF OVERVIEW OF DIGITAL SOUND FIELD PROGRAMS

No.	PROGRAM	FEATURE
1	<p>DOLBY PRO LOGIC ()</p> <p>Functions when the input signal is analog or PCM audio, or encoded with the Dolby Digital in 2-channel. Speaker output: main, center, rear</p> <p>DOLBY DIGITAL ()</p> <p>Functions when the input signal is encoded with the Dolby Digital (not in 2-channel). Speaker output: main, center, rear</p>	<p>Reproduces video discs, video tapes and similar sources which are Dolby Surround encoded and bear the "DOLBY SURROUND" logo.</p> <p>The built-in Dolby Pro Logic Surround decoder or Dolby Digital decoder precisely reproduces sounds and sound effects of a source encoded with Dolby Surround. The realization of a highly efficient decoding process improves crosstalk and channel separation and makes sound positioning smoother and more precise.</p>
2	<p>DOLBY PRO LOGIC ENHANCED ()</p> <p>Functions when the input signal is analog or PCM audio, or encoded with the Dolby Digital in 2-channel. Speaker output: main, center, rear</p> <p>DOLBY DIGITAL ENHANCED ()</p> <p>Functions when the input signal is encoded with the Dolby Digital (not in 2-channel). Speaker output: main, center, rear</p>	<p>Reproduces video discs, video tapes and similar sources which are Dolby Surround encoded and bear the "DOLBY SURROUND" logo.</p> <p>This program ideally simulates the multi-surround speaker systems of the 35 mm film theater. The Dolby Surround decoding and the digital sound field processing is precisely performed without altering the original sound orientation. The surround effects produced by this sound field folds around the viewer naturally from the rear to the left and right and toward the screen.</p> <p>Note: If the main channel sound is considerably altered by overadjustment of BASS or TREBLE, the relationship with the rear channels may produce an unnatural effect.</p>
3	<p>70 mm MOVIE THEATER ()</p> <p>Functions when the input signal is analog or PCM audio, or encoded with the Dolby Digital in 2-channel. Speaker output: main, center, rear</p> <p>DIGITAL MOVIE THEATER ()</p> <p>Functions when the input signal is encoded with the Dolby Digital (not in 2-channel). Speaker output: main, center, rear</p>	<p>Ideal for reproducing video discs, video tapes and similar sources which are Dolby Surround encoded and bear the "DOLBY SURROUND" logo.</p> <p>This program is ideal for precisely reproducing the sound design of the newest 70 mm/Dolby Digital multi-track films. The sound field is made to be similar to that of the newest movie theaters, so the reverberations of the sound field itself are restrained as much as possible. The three dimensional feeling of the sound field is emphasized, and dialog is precisely oriented on the screen. You can enjoy watching Sci-Fi, adventure movies, etc. with considerable presence.</p>

No.	PROGRAM	FEATURE
4	<p>MONO MOVIE (<input type="checkbox"/> DSP) Functions when the input signal is analog or PCM audio, or encoded with the Dolby Digital in 2-channel. Speaker output: main, center, rear</p> <p>(<input type="checkbox"/> DIGITAL <input type="checkbox"/> DSP) Functions when the input signal is encoded with the Dolby Digital (not in 2-channel). Speaker output: main, center, rear</p>	<p>This program is designed specifically to enhance mono source programs. Compared to a strictly mono setting, the sound image created in this mode is wider and slightly forward of the speaker pair, lending an immediacy to the overall sound. It is particularly effective when used with old mono movies, news broadcasting and dialog.</p>
5	<p>TV SPORTS (<input type="checkbox"/> DSP) Functions when the input signal is analog or PCM audio, or encoded with the Dolby Digital in 2-channel. Speaker output: main, center, rear</p> <p>(<input type="checkbox"/> DIGITAL <input type="checkbox"/> DSP) Functions when the input signal is encoded with the Dolby Digital (not in 2-channel). Speaker output: main, center, rear</p>	<p>This program is furnished with a tight sound field in which the sound will not spread excessively on the front side, but the rear surround side produces a dynamic sound expansion. This program is the most suitable for sports programs.</p>
6	<p>DISCO (<input type="checkbox"/> DSP) Functions when the input signal is analog or PCM audio, or encoded with the Dolby Digital in 2-channel. Speaker output: main, rear</p> <p>(<input type="checkbox"/> DIGITAL <input type="checkbox"/> DSP) Functions when the input signal is encoded with the Dolby Digital (not in 2-channel). Speaker output: main, center, rear</p>	<p>This program recreates the acoustic environment of a lively disco in the heart of a very lively city. The sound is dense and highly concentrated. It is also characterized by a high-energy, "immediate" sound.</p>
7	<p>ROCK CONCERT (<input type="checkbox"/> DSP) Functions when the input signal is analog or PCM audio, or encoded with the Dolby Digital in 2-channel. Speaker output: main, rear</p> <p>(<input type="checkbox"/> DIGITAL <input type="checkbox"/> DSP) Functions when the input signal is encoded with the Dolby Digital (not in 2-channel). Speaker output: main, center, rear</p>	<p>This program is ideally suited for rock music. You will experience a very dynamic and lively sound field.</p>
8	<p>CONCERT HALL (<input type="checkbox"/> DSP) Functions when the input signal is analog or PCM audio, or encoded with the Dolby Digital in 2-channel. Speaker output: main, rear</p> <p>(<input type="checkbox"/> DIGITAL <input type="checkbox"/> DSP) Functions when the input signal is encoded with the Dolby Digital (not in 2-channel). Speaker output: main, center, rear</p>	<p>In this program, the center will appear to be deep behind the main speakers, creating an expansive, large hall ambience. Orchestra and opera music are suited to this sound field.</p>

Note: When the NONE position is selected on "1. CNTR" in the SET MENU mode, no sound is output from the center speaker(s).

PLAYING A SOURCE WITH THE DIGITAL SOUND FIELD PROCESSOR (DSP) EFFECT

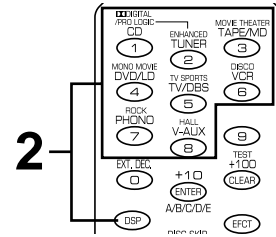
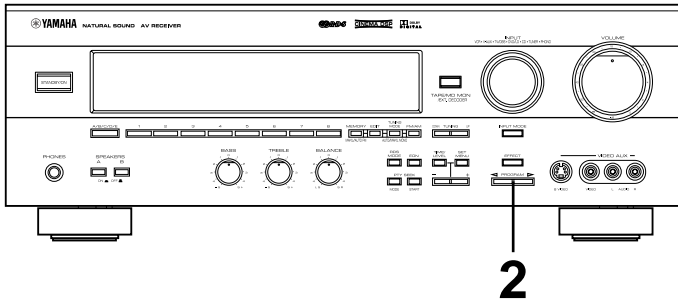

1 Follow steps 1 to 7 shown in "BASIC OPERATIONS" on pages 25 to 26.

2 Select the desired DSP program that is suitable for the source.

Front panel

Remote control

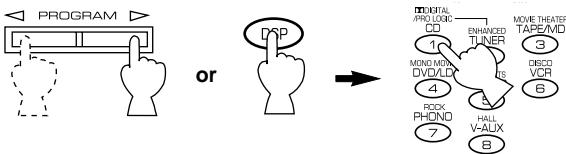

Press **DSP**. While the indicator lights up for about three seconds, select a **DSP program** using the numeric buttons (1 to 8).

* If the **SELECTOR DIAL** is set to the DSP position, you can also select a DSP program using the numeric buttons (1 to 8).

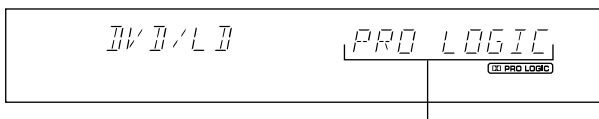

The name of selected program appears on the display.

3 If desired, adjust the delay time and the output level of each speaker. (For details, see pages 44 and 45.)

Notes

- You can select the program for each of the input sources. Once you select a program, it is linked with the input source selected at that time. So, when you select the input source next time, the same program is automatically called.
- If you prefer to cancel the DSP, press **EFFECT** or **EFCT ON/OFF**. The sound will be the normal 2-channel stereo without surround sound effect.
- When a monaural sound source is played with **DOLBY PRO LOGIC** or **DOLBY PRO LOGIC ENHANCED**, no sound is heard from the main speakers and the rear speakers. Sound is heard only from the center speaker. However, if the NONE position is selected on "1. CNTR" in the SET MENU mode, the main speakers output the sound of the center channel.
- If the main-source sound is considerably altered by overadjustment of **BASS** or **TREBLE** when this unit's Dolby Pro Logic Surround decoder or Dolby Digital decoder is used, the relationship between the center and rear channels may produce an unnatural effect.

This unit incorporates a Dolby Digital decoder and a Dolby Pro Logic Surround decoder for multi-channel sound reproduction of sources encoded with Dolby Surround. The operation of these decoders can be controlled by selecting a corresponding DSP program including the combined operation of YAMAHA DSP and Dolby Digital or Dolby Pro Logic Surround.

To enjoy a video source with the Dolby Pro Logic Surround or Dolby Digital decoded

When you select the program **DOLBY PRO LOGIC/DOLBY DIGITAL**, **DOLBY PRO LOGIC ENHANCED/DOLBY DIGITAL ENHANCED** or **70 mm MOVIE THEATER/DIGITAL MOVIE THEATER**, and the input signal of the source is 2-channel stereo, Dolby Pro Logic Surround is decoded. When some program is selected and the input signal of the source is encoded with Dolby Digital, Dolby Digital is automatically decoded.

* The following indicators on the display show you what sound processing is being made.

Lights up when the Dolby Digital is being decoded and the input signals of selected source encoded with Dolby Digital is not in 2-channel.

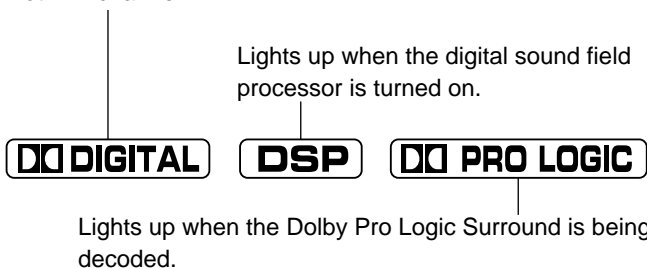

* In addition, for the program **DOLBY PRO LOGIC/DOLBY DIGITAL**, **DOLBY PRO LOGIC ENHANCED/DOLBY DIGITAL ENHANCED** or **70 mm MOVIE THEATER/DIGITAL MOVIE THEATER**, the name of the program on the display will change according to the type of decoding. (For details, see page 40.)

Note

If the input signals of the source are encoded with Dolby Digital in 2-channel only, the sound processing for them is similar to that for analog or PCM audio signals.

To cancel the effect sound

EFFECT on the front panel and **EFCT ON/OFF** on the remote control transmitter make it simple to compare the normal stereo sound with the fully processed effect sound.

To cancel the effect sound and monitor only the main sound, press **EFFECT** or **EFCT ON/OFF**. Press **EFFECT** or **EFCT ON/OFF** once more to turn effect sounds on.

Front panel

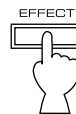

or

Remote control



Notes

- If the effect sound is canceled when signals encoded with Dolby Digital are input to this unit, signals of all channels are mixed and are output from the main speakers.
- If **EFFECT** or **EFCT ON/OFF** is pressed to turn effect sounds off when the Dolby Digital is decoded, it may happen that the sound is output faintly or not output normally depending on the source. In that case, press **EFFECT** or **EFCT ON/OFF** to turn effect sounds on, or use input signals not encoded with Dolby Digital.

ADJUSTING DELAY TIME AND SPEAKER OUTPUT LEVELS

When using the digital sound field processor including the Dolby Pro Logic Surround decoder or the Dolby Digital decoder, you can adjust the delay time between the main sound and effect sound, and each speaker's output level as you prefer.

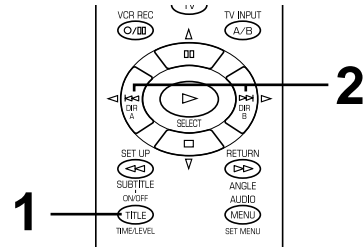
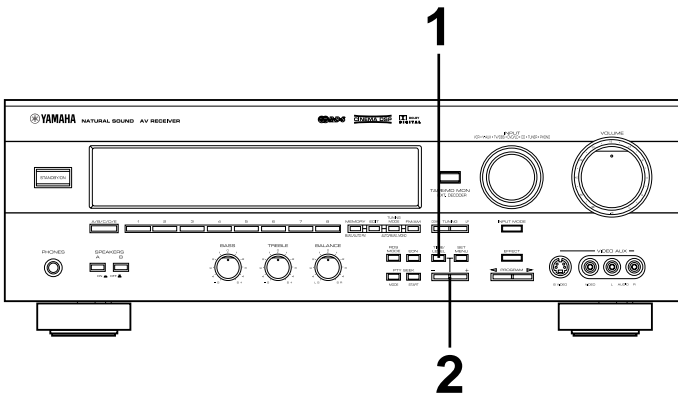

Adjusting method

If you are using the remote control transmitter, set the **SELECTOR DIAL** to the AMP/TUN or DSP position on the remote control transmitter.



or



1 Press **TIME/LEVEL** once or more until the name of item which you want to adjust appears on the display.

Front panel

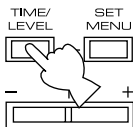

Remote control

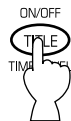

or

* After pressing **TIME/LEVEL** once on the remote control transmitter, you can also select the name of item by pressing ∇ .

When pressed, the selection changes as follows:

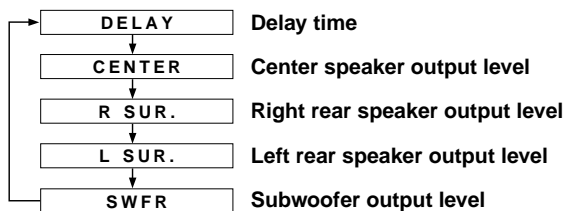

* Pressing Δ on the remote control transmitter changes the selection in the reverse order.

* Depending on the mode of this unit, you cannot select all items.

2 Press + or – to adjust the settings for delay time or speaker output levels.

Front panel

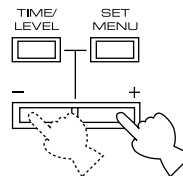

Remote control

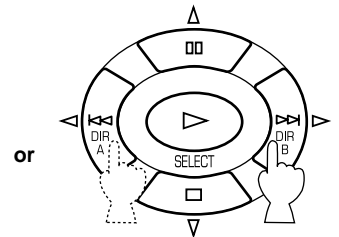

3 Repeat steps 1 to 3 to adjust settings on any other item.

Adjusting delay time

You can adjust the time difference between the beginning of the sound from the main speakers and the beginning of the effect sound from the rear speakers.

The larger the value, the later the effect sound is generated. This adjustment can be made to all programs individually.

Notes

- Adding too much delay will cause an unnatural effect with some sources.
- When + or – is pressed, the sound is momentarily interrupted.

Program	Control range (ms)	Preset value
1. DOLBY PRO LOGIC	15 to 30	20
DOLBY DIGITAL	0 to 15	5
2. DOLBY PRO LOGIC ENHANCED	15 to 30	20
DOLBY DIGITAL ENHANCED	0 to 15	5
3. 70 mm MOVIE THEATER	15 to 30	20
DIGITAL MOVIE THEATER	1 to 99	16
4. MONO MOVIE	1 to 99	49
5. TV SPORTS	1 to 99	9
6. DISCO	1 to 99	40
7. ROCK CONCERT	1 to 99	16
8. CONCERT HALL	1 to 99	44

Adjusting output level of the center, right rear and left rear speakers, and subwoofer

If desired, you can adjust the sound output level of each speaker even if the output level is already set in "SPEAKER BALANCE ADJUSTMENT" on pages 22 to 24.

Notes

- Output level of the center speaker cannot be adjusted when the program **DISCO**, **ROCK CONCERT** or **CONCERT HALL** is selected, and the input signal is analog, PCM audio, or encoded with Dolby Digital in 2-channel.

- If the function "1. CNTR" in the SET MENU mode is set to the NONE position, the sound output level of the center speaker cannot be adjusted. This is because, in this mode, the center sound is automatically output from the left and right main speakers.
- Once the output level is adjusted, the level will be the same for all digital sound field programs.

Speakers	Control range (dB)	Preset value
CENTER	MIN, -20 to +10	0
RIGHT SURROUND (Rear)	MIN, -20 to +10	0
LEFT SURROUND (Rear)	MIN, -20 to +10	0
SUBWOOFER	MIN, -20 to 0	0

Note

The values of the delay time, center/rear/subwoofer output level you set the last time will remain memorized even when this unit is in the standby mode. However, if the power cord is kept disconnected for more than one week, these values will automatically change back to the original factory settings.

ADJUSTMENTS IN THE “SET MENU” MODE

The following ten types of functions maximize the performance of your system and expand your enjoyment for audio listening and video watching.

1. **CNTR (CENTER SPEAKER)**
2. **REAR (REAR SPEAKER)**
3. **MAIN (MAIN SPEAKER)**
4. **BASS (LFE/BASS OUT)**
5. **M.LVL (MAIN LEVEL)**
6. **LFE (LFE LEVEL)**
7. **D.RNG (DYNAMIC RANGE)**
8. **C.DELAY (CENTER DELAY)**
9. **GUARD (MEMORY GUARD)**
10. **INPUT (INPUT MODE)**

For details on “1. CNTR”, “2. REAR”, “3. MAIN”, “4. BASS” and “5. M.LVL”, see page 20. (Once you have selected the appropriate modes, you do not have to change settings unless any alteration is made in your speaker system.)

6. LFE [Adjusting the output level of the LFE (low frequency effect) channel]

Control range: -20 dB to 0 dB (in 1 dB step)
Preset value: 0 dB

* This adjustment is effective only when the Dolby Digital is decoded and the signals of selected source encoded with the Dolby Digital contain LFE signals.

Adjusts the output level of the LFE (low frequency effect) channel. If the LFE signals are mixed with signals of other channels to output them from the same speakers, the ratio of LFE signal level to the level of other signals are adjusted. (See page 5 for details about the LFE channel.)

7. D.RNG (Adjusting dynamic range)

Choices: MAX/STD/MIN
Preset position: MAX

* This adjustment is effective only when the Dolby Digital is decoded.

MAX: “Dynamic range” is the difference between the maximum level and the minimum level of sounds. Sounds on a movie originally designed for movie theaters feature very wide dynamic range. Dolby Digital technology can bring the original sound track into a home audio format with this wide dynamic range unchanged. In this position, a source encoded with the Dolby Digital is reproduced in the original sound track’s wide dynamic range providing you with powerful sounds just like in a movie theater. Selecting this position will be even better if you can listen to a source in a high output level in a room specially soundproofed for audio/video enjoyment.

STD (Standard):

Powerful sounds of extremely wide dynamic range are not always suitable for home use. Depending upon the condition of your listening environment, it may not be possible to increase the sound output level as high as a movie theater. However, in a level suitable for listening to in your room, the low level parts of source sound often cannot be heard so well because they will be lost among noises in your environment.

Dolby Digital technology also made it possible to reduce an original sound track’s dynamic range for a home audio format by “compressing” the data of sound.

In this position, a source encoded with the Dolby Digital is reproduced in the “compressed” dynamic range of the source suitable for low level listening.

MIN: In this position, dynamic range is more reduced than in the STD position. Selecting this position will be effective when you must listen to a source at lower level.

8. C.DELAY [Adjusting the delay of center sounds (dialog etc.)]

Control range: 0 ms to 5 ms (in 1 ms step)

Preset value: 0 ms

- * This adjustment is effective only when the Dolby Digital is decoded and the signals of selected source encoded with the Dolby Digital contain center-channel signals.

Adjusts the delay between the main sounds (at the main channels) and dialog etc. (at the center channel).
The larger the value, the later the dialog etc. is generated.

This is for making sounds from the left main, center and right main speakers reach your listening position at the same time. This is achieved by delaying the sound from the center speaker if the distance from the center speaker to your listening position is shorter than the distance from the left or right main speaker to your listening position.

9. GUARD

Choices: ON/OFF

Preset position: OFF

If you wish to prevent accidental alteration to SET MENU and other adjustments on this unit, select ON. The following functions on this unit can be locked by this operation.

- Functions in the SET MENU mode
- Functions in the TIME/LEVEL mode
- Functions when using TEST

10. INPUT (Selecting the initial input mode of the sources connected to the TV/DBS input terminals)

For the sources connected to the TV/DBS input terminals of this unit only, you can designate the input mode that is automatically selected when the power of this unit is switched on.

- AUTO:** In this position, the AUTO input mode is always selected when the power of this unit is switched on.
- LAST:** In this position, the input mode you selected last time is memorized and will not be changed even if the power of this unit is switched on.

- * See page 27 for details on switching the input mode.

Adjusting method

Operations should be made while watching the information on this unit's display.

If you are using the remote control transmitter, set the **SELECTOR DIAL** to the AMP/TUN or DSP position on the remote control transmitter.



or



Press **SET MENU** once or more so that the title of function which you want to change appears on the display.

Front panel

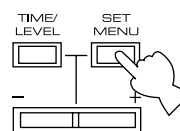

or

Remote control



- * After pressing **SET MENU** once on the remote control transmitter, you can also select the title by pressing ▽. (Pressing Δ goes back one selection.)

Press + or – to select any desired position or edit parameters on the function.

Front panel

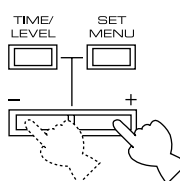

or

Remote control

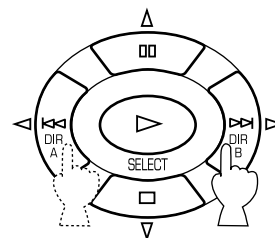

Repeat these steps to change and adjust settings on any other function.

REMOTE CONTROL TRANSMITTER

You can use this remote control transmitter to control not only this unit but also other components connected to it. This is factory set to control this unit and most YAMAHA audio components. To control other brands of components, you must preset the remote control transmitter with the manufacturer's codes listed on pages 397 to 402.

Components which can be controlled

There are nine positions that you can select to control connected components with this remote control transmitter. When turning the **SELECTOR DIAL**, the position changes as follows:

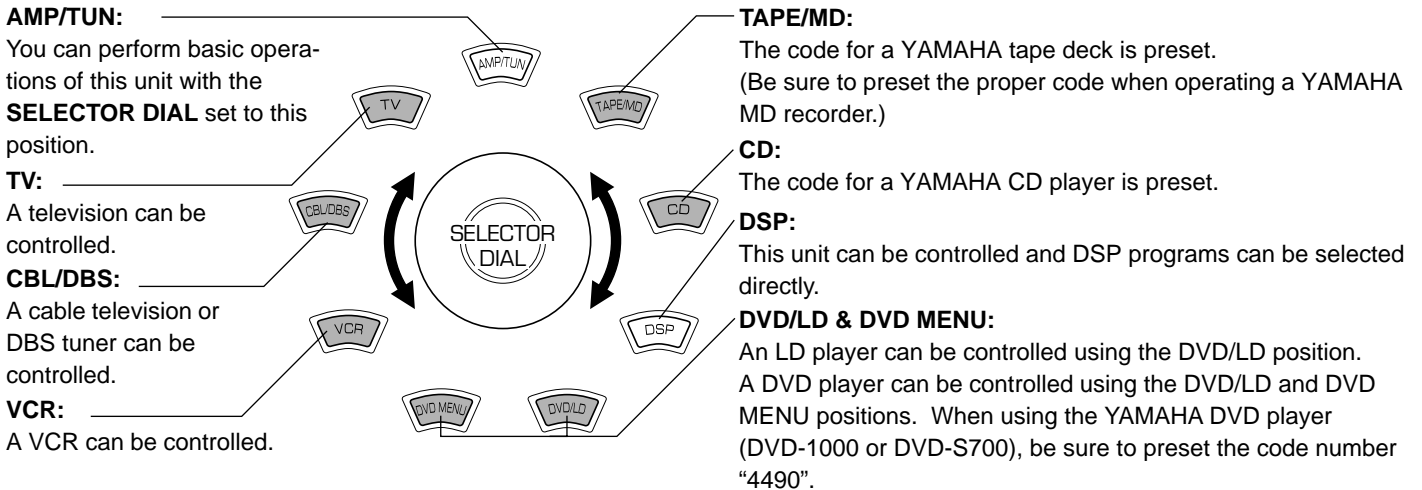

Notes

- The shaded positions in the diagram above indicate that you can preset the code for the manufacturer of your component. Note that you can preset only one code for one position. For details, see "SETUP CODES" on page 53.
- The DVD/LD and DVD MENU positions
 - Be sure that the **SELECTOR DIAL** is set to the DVD/LD position when presetting the code for a DVD or an LD player. The code that you preset to the DVD/LD position is also preset to the DVD MENU position simultaneously. You cannot preset the code for a DVD player when the **SELECTOR DIAL** is set to the DVD MENU position.
 - DVD MENU operations cannot be performed for some DVD players.
- When using a second (and third) VCR (For details, see "To use a second (and third) VCR" on page 53.)
 - If you are not using a CBL/DBS (cable TV or DBS tuner), the second (or third) VCR can be preset using the CBL/DBS position.
 - If you are not using a DVD player, the second (or third) VCR can be preset using the DVD MENU position. Note that in this case you must preset a code for an LD player to the DVD/LD position even if an LD player is not used.

Basic Operations

- Select the component that you want to control by turning the **SELECTOR DIAL**.
Note: Turn the **SELECTOR DIAL** until it stops with a click.

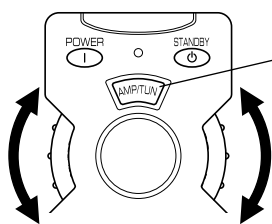

The component name is displayed in this window.

- Press the desired operation button.
Note: Press the button with the remote control transmitter aimed at the front panel.

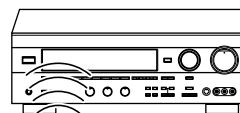

Indicator
The indicator will flash when the button is pressed.

Faintly colored buttons do not function.

AMP/TUN

Note: TV POWER and TV VOLUME function if you have preset the code for your TV.

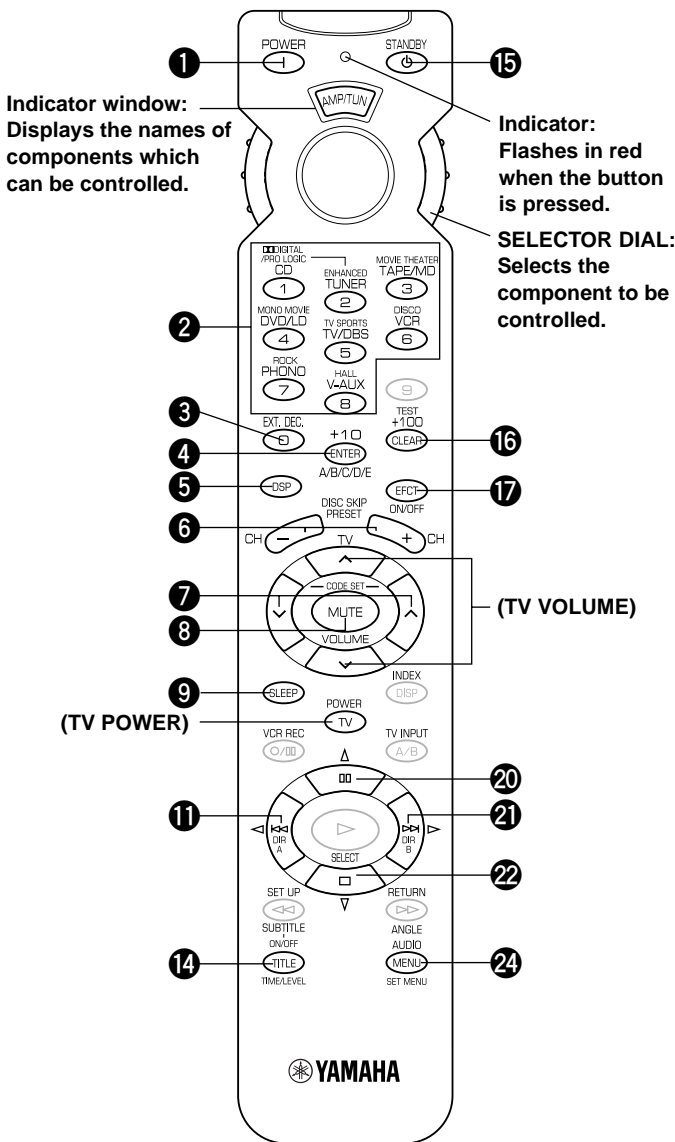

- 1 POWER**
This button turns this unit on.
- 2 INPUT**
Press these buttons to select the program source.
- 3 EXT. DEC.**
Press this button when using an external decoder.
- 4 A/B/C/D/E**
Press this button to select a group of preset stations.
- 5 DSP selector**
Press this button. While the indicator lights up for about three seconds, select a DSP program using the number buttons (1 to 8). No DSP program can be selected after the indicator goes off.
- 6 PRESET (+/-)**
Press these buttons to select the preset station number.
- 7 VOLUME (^ v)**
Press these buttons to adjust the volume level.
- 8 MUTE**
Press this button to mute the sound. To cancel mute, press this button once more, or press the operation buttons of this unit.
- 9 SLEEP**
Press this button to set the SLEEP timer.
- 11 ◀ (LEFT)**
This button is used to adjust the settings of the SET MENU mode and the TIME/LEVEL mode.
- 14 TIME/LEVEL**
Press this button to select the item in the TIME/LEVEL mode.
- 15 STANDBY**
Press this button to turn this unit into Standby mode.
- 16 TEST**
Press this button to output a test tone for adjusting the output level of the speakers.
- 17 EFCT (EFFECT) ON/OFF**
Press this button to switch the DSP program on or off.
- 20 Δ (BACK)**
Press this button to go back one selection in the SET MENU mode and TIME/LEVEL mode.
- 21 ▷ (RIGHT)**
This button is used to adjust the settings of the SET MENU mode and the TIME/LEVEL mode.
- 22 ▽ (NEXT)**
Press this button to advance one selection in the SET MENU mode and TIME/LEVEL mode.
- 24 SET MENU**
Press this button to select functions in the SET MENU mode.

DSP

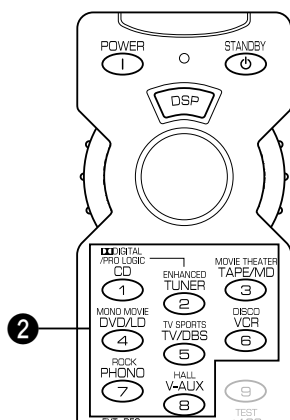

- 2 DSP program**
Press these buttons to select the DSP program (1 to 8). When you select the input source, set the **SELECTOR DIAL** to the AMP/TUN position.

Note: The function of all buttons other than **DSP program** is the same as with the AMP/TUN position.

Faintly colored buttons do not function. For the buttons which are not described here, see "AMP/TUN" on page 49. For details, please refer to the owner's manual for each component.

■ TAPE/MD

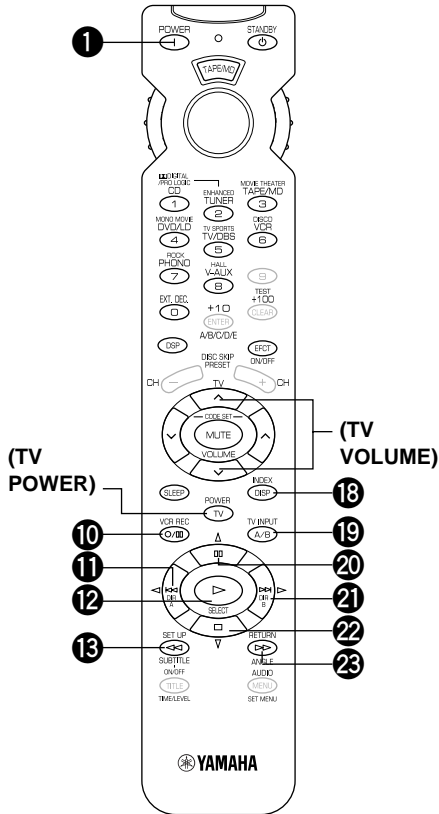

Notes:

- **TV POWER** and **TV VOLUME** function if you have preset the code for your TV.
- Be sure to preset the proper code for your MD recorder.

TAPE

1 POWER

This button turns this unit on under the default settings. (The code for a YAMAHA tape deck is preset as the default code.) If other codes are preset, only those preset tape decks having a remote controller with a POWER button will be turned on.

10 ○/⏸ (REC/PAUSE)

Press this button to pause recording on a tape deck.

11 ◀ DIR A

Press this button to select the playing direction of deck A.

12 ▷ (PLAY)

Press this button to play a tape.

13 ◀◀ (REWIND)

Press this button to rewind a tape.

19 DECK A/B

Press this button to select double cassette tape deck A or B.

21 ▷ DIR B

Press this button to select the playing direction of deck B.

22 □ (STOP)

Press this button to stop operation of a tape.

23 ▷▷ (FAST FORWARD)

Press this button to fast forward a tape.

MD

1 POWER

This button turns this unit on if you have preset the code for the YAMAHA MD recorder. If other codes are preset, only those preset MD recorders having a remote controller with a POWER button will be turned on.

10 ○/⏸ (REC/PAUSE)

11 ◀◀ (SKIP)

12 ▷ (PLAY)

13 ◀◀ (BACKWARD)

18 DISPLAY

20 ⏸ (PAUSE)

21 ▶▶ (SKIP)

22 □ (STOP)

23 ▷▷ (FAST FORWARD)

■ CD

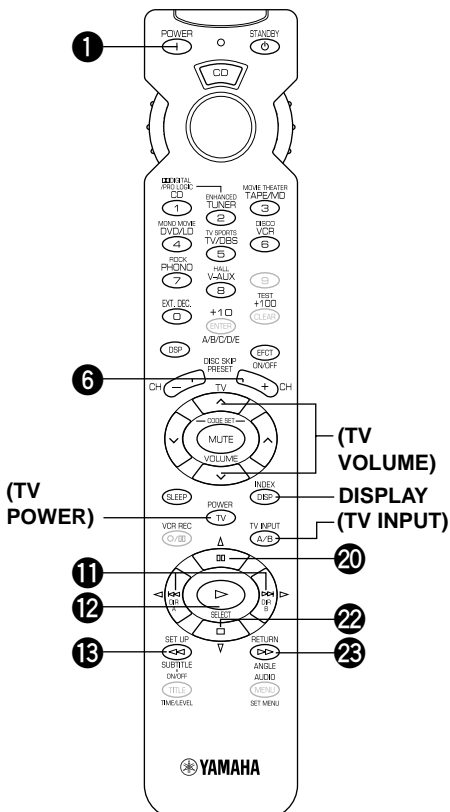

Note: **TV POWER**, **TV VOLUME** and **TV INPUT** function if you have preset the code for your TV.

1 POWER

This button turns this unit on under the default settings. (The code for a YAMAHA CD player is preset as the default code.) If other codes are preset, only those preset CD players having a remote controller with a POWER button will be turned on.

6 DISC SKIP (+/-)

Press this button to skip to the next or previous CD.

11 ▶▶, ◀◀ (SKIP)

Press ▶▶ to skip to the next track. Press ◀◀ to skip to the previous track.

12 ▷ (PLAY)

Press this button to play a CD.

13 ◀◀ (BACKWARD)

Press this button to backward the track that is playing.

20 ⏸ (PAUSE)

Press this button to pause operation. This button functions as **PAUSE/STOP** for operating YAMAHA CD players under default settings.

22 □ (STOP)

Press this button to stop operation. This button functions as **PAUSE/STOP** for operating YAMAHA CD players under default settings.

23 ▷▷ (FAST FORWARD)

Press this button to fast forward the track that is playing.

Faintly colored buttons do not function. For the buttons which are not described here, see "AMP/TUN" on page 49. For details, please refer to the owner's manual for each component.

DVD/LD

POWER

(DVD) This button turns this unit on under the default settings. (The code for a YAMAHA DVD player is preset as the default code.) If other codes are preset, only those preset DVD players having a remote controller with a POWER button will be turned on.

(LD) This button turns this unit on if you have preset the code for the YAMAHA LD player. If other codes are preset, only those preset LD players having a remote controller with a POWER button will be turned on.

Note: TV POWER, TV VOLUME and TV INPUT function if you have preset the code for your TV.

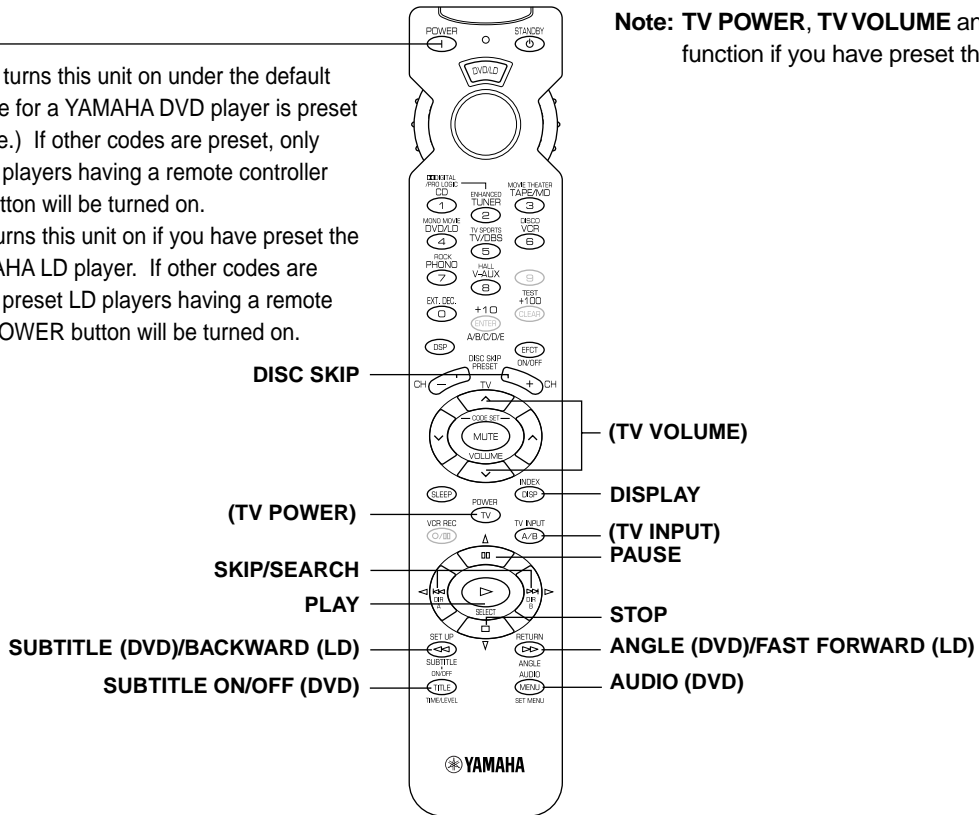

DVD MENU

POWER

(DVD) This button turns this unit on under the default settings. (The code for a YAMAHA DVD player is preset as the default code.) If other codes are preset, only those preset DVD players having a remote controller with a POWER button will be turned on.

Note: TV POWER, TV VOLUME and TV INPUT function if you have preset the code for your TV.

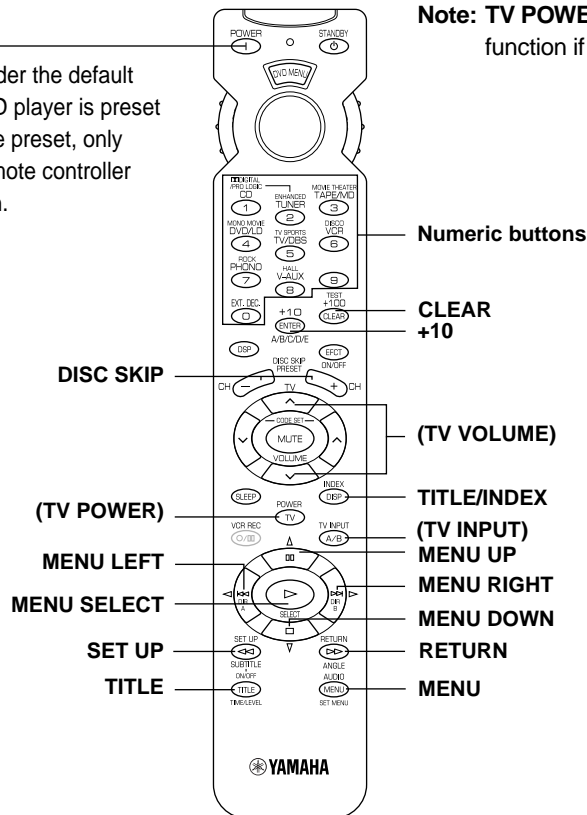

Faintly colored buttons do not function. For the buttons which are not described here, see "AMP/TUN" on page 49. For details, please refer to the owner's manual for each component.

VCR

Note: TV POWER, TV VOLUME and TV INPUT function if you have preset the code for your TV.

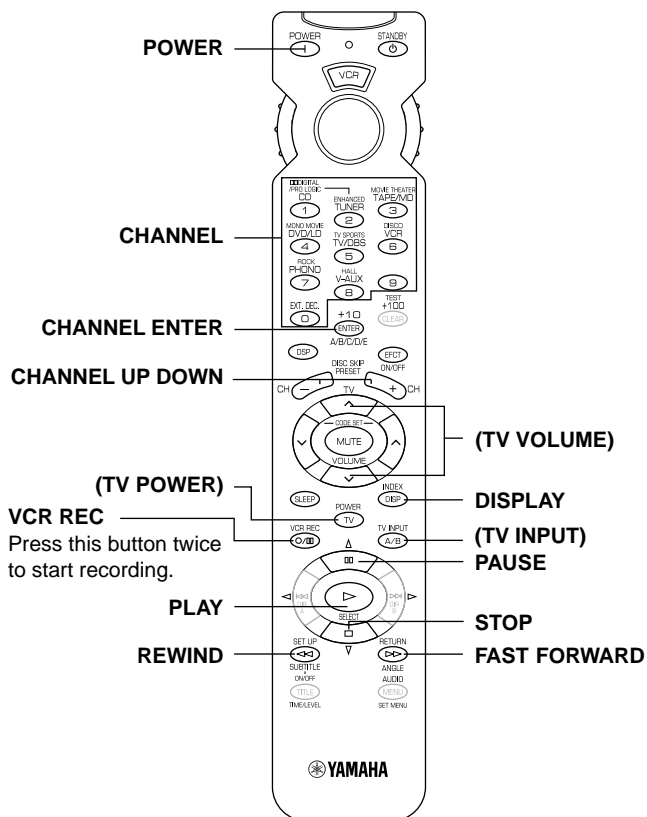

TV

Note: You can control your VCR if you have preset the code for it.

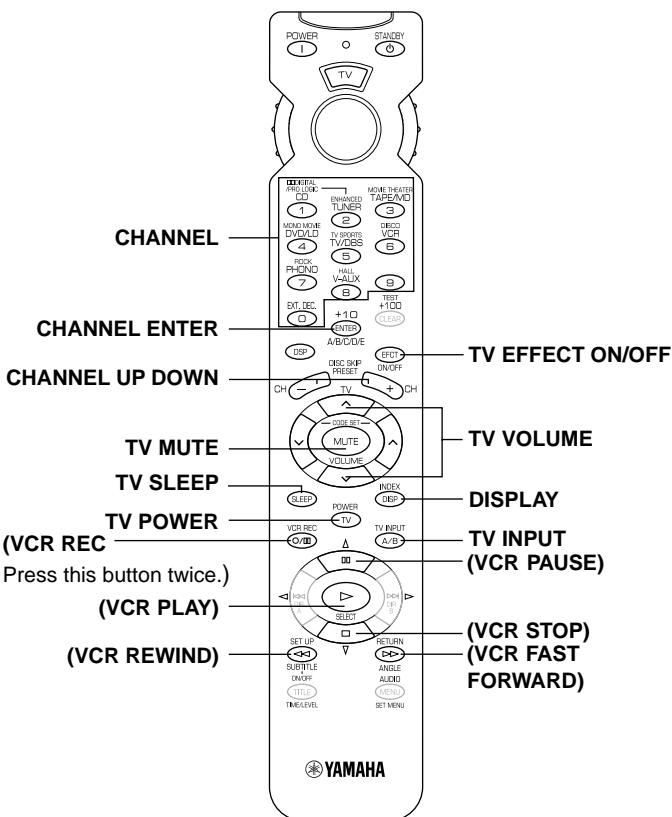

CBL/DBS

Note: TV POWER, TV VOLUME and TV INPUT function if you have preset the code for your TV.

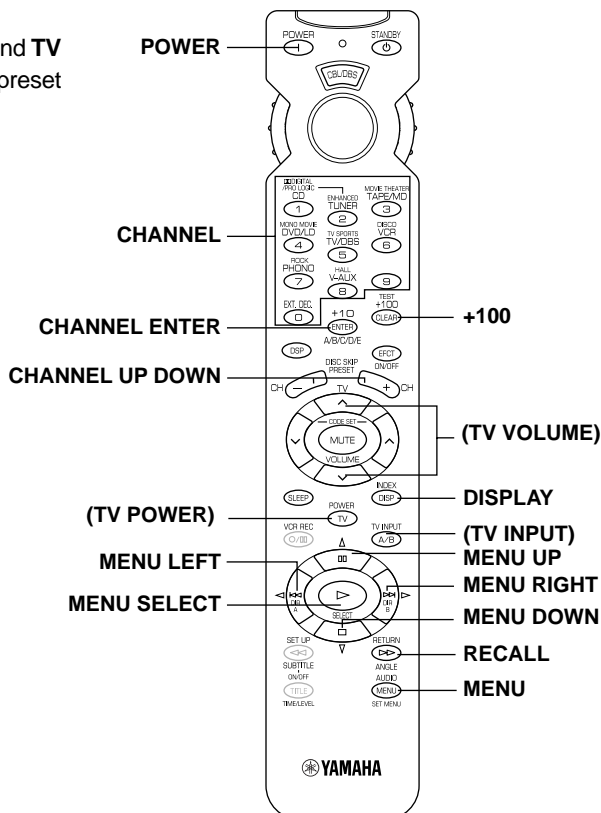

Presetting the remote control transmitter

Perform the presetting procedure for each component you want to control with this remote control transmitter.

Note: If your component does not respond to any of the codes listed for the manufacturer, use the original remote control that came with the component.

To control your components (MD recorder, DVD player, TV etc.)

1. Turn on the component to be used.
2. Set the **SELECTOR DIAL** to the desired component (TAPE/MD, DVD/LD, TV etc.).

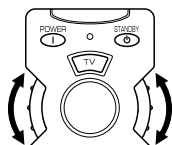

3. Press both **VOLUME** buttons (^ v) at the same time until the indicator flashes twice.

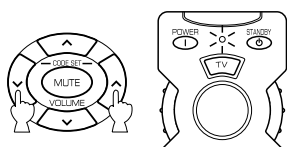

4. Use the numeric buttons to enter the four-digit manufacturer's code for the component to be used. Make sure that the indicator flashes twice. If the indicator does not flash, repeat step 3 and re-enter the code.

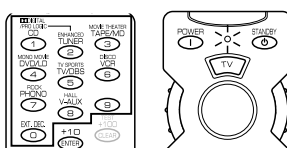

5. Press **POWER** (or any other button) on the remote control transmitter to check if you have preset the code correctly. If the component cannot be controlled using the remote control transmitter, try entering another code for the same manufacturer.

To use a second (and third) VCR

You can use the CBL/DBS and/or DVD MENU positions to control a second VCR (and/or third) if a CBL (or DBS) or DVD player is not used.

If you are using the DVD MENU position for a second (or third) VCR, you must preset a code for an LD player to the DVD/LD position.

1. Turn on the VCR to be used.
2. Set the **SELECTOR DIAL** to the CBL/DBS or DVD MENU position.

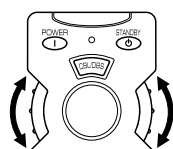

3. Press both **VOLUME** buttons (^ v) at the same time until the indicator flashes twice.

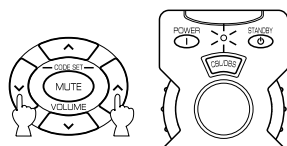

4. Press **MUTE**.

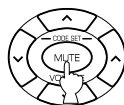

5. Use the numeric buttons to enter the four-digit code for a second (or third) VCR. Make sure that the indicator flashes twice. If the indicator does not flash, repeat step 3 and 4, and re-enter the code.

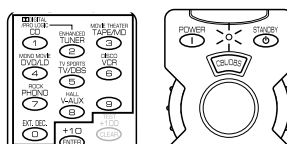

6. Press **POWER** (or any other button) on the remote control transmitter to check if you have preset the code correctly. If the VCR cannot be controlled using the remote control transmitter, try entering another code for the same manufacturer.

Returning to the default code

To return all components to the default code, follow these steps.

1. Press both **VOLUME** buttons (^ v) at the same time until the indicator flashes twice.
2. Enter the code number "9987".
3. Make sure that the indicator flashes twice.

To return each component to the default code, follow these steps.

1. Set the **SELECTOR DIAL** to the component to be return to the default code.
2. Press both **VOLUME** buttons (^ v) at the same time until the indicator flashes twice.
3. Enter the code number "9999".
4. Make sure that the indicator flashes twice.

The following codes are preset as the default code.

Default codes

POSITION	Component	Code
TV	TV	0037
CBL/DBS	DBS tuner	2455
VCR	VCR	3072
DVD/LD	DVD player	4545 YAMAHA
CD	CD player	6187 YAMAHA
TAPE/MD	Tape deck	8524 YAMAHA

We recommend that you write all code numbers you have preset on the "Quick Reference Card".

NOTES ABOUT THE REMOTE CONTROL TRANSMITTER

Battery installation

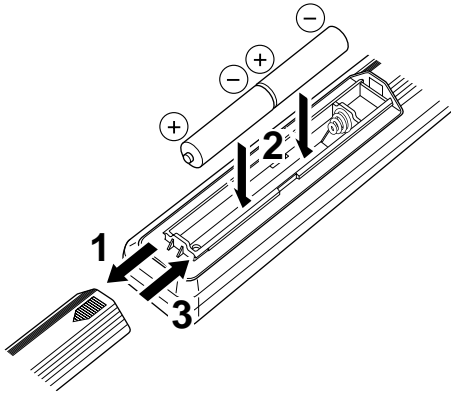

Battery replacement

If the remote control transmitter operates only when it is closed to this unit, the batteries are weak. Replace both batteries with new ones.

Be sure to replace batteries within about two minutes. If it takes longer than two minutes, the codes preset for the remote control transmitter will return to the default codes.

Notes

- Use only AA, R6, UM-3 batteries for replacement.
- Be sure the polarities are correct. (See the illustration inside the battery compartment.)
- Remove the batteries if the remote control transmitter will not be used for an extended period of time.
- If batteries leak, dispose of them immediately. Avoid touching the leaked material or letting it come in contact with clothing, etc. Clean the battery compartment thoroughly before installing new batteries.

Remote control transmitter operation range

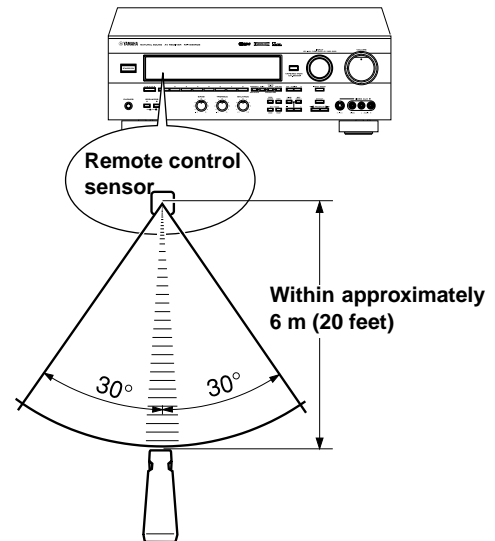

Notes

- There should be no large obstacles between the remote control transmitter and this unit.
- If the remote control sensor is directly illuminated by strong lighting (especially an inverter type of fluorescent lamp etc.), it might cause the remote control transmitter not to work correctly. In this case, reposition this unit to avoid direct lighting.

TROUBLESHOOTING

If the unit fails to operate normally, check the following points to determine whether the fault can be corrected by the simple measures suggested. If it cannot be corrected, or if the fault is not listed in the SYMPTOM column, disconnect the power cord and contact your authorized YAMAHA dealer or service center for help.

	SYMPTOM	CAUSE	REMEDY
Amplifier	The unit fails to turn on when STANDBY/ON is pressed, or turns into the standby mode suddenly soon after the power is turned on.	Power cord is not plugged in or is not completely inserted.	Firmly plug in the power cord.
		The IMPEDANCE SELECTOR switch on the rear panel is not fully set to the upper or lower end.	Set the switch fully to the upper or lower end.
	The unit does not work normally.	There is an influence of strong external noise (lightning, excessive static electricity, etc.) or a misoperation while using this unit.	Turn this unit into the standby mode and disconnect the AC power cord from the AC outlet. After about 30 seconds have passed, connect the power and operate this unit again.
	No sound or no picture.	Incorrect output cord connections.	Connect the cords properly. If the problem persists, the cords may be defective.
		Appropriate input source is not selected.	Select an appropriate input source with INPUT .
		SPEAKERS are not set properly.	Set SPEAKERS corresponding to the speakers in use to the ON position.
		Speaker connections are not secure.	Secure the connections.
	No picture.	There is no S video terminal connection between this unit and the TV, though S video signals are input to this unit.	Connect this unit's S VIDEO MONITOR OUT terminal to the TV's S video input terminal.
	The sound suddenly goes off.	The protection circuit has been activated because of short circuit etc.	Turning the unit into the standby mode and then on again will reset the protection circuit.
		The SLEEP timer has functioned.	Cancel the SLEEP timer function.
	Only one side speaker outputs sound.	Incorrect setting of BALANCE .	Adjust it to the appropriate position.
		Incorrect cord connections.	Connect the cords properly. If the problem persists, the cords may be defective.
	A "humming" sound can be heard.	Incorrect cord connections.	Firmly connect the audio plugs. If the problem persists, the cords may be defective.
		No connection from the turntable to the GND terminal.	Make the GND connection between the turntable and this unit.
	The volume level is low while playing a record.	The record is being played on a turntable with an MC cartridge.	The turntable should be connected to the unit through the MC head amplifier.
	The volume level cannot be increased, or the sound is distorted.	The component connected to the REC OUT terminals of this unit is in the standby mode.	Turn the power to the component on.
	No sound from the rear speakers.	The sound output level of the rear speakers is set to minimum.	Raise the sound output level of the rear speakers.
		A monaural sound source is being played in DOLBY PRO LOGIC or DOLBY PRO LOGIC ENHANCED mode.	Select another sound field program suitable for the monaural sound source.
	No sound from the center speaker.	The sound output level of the center speaker is set to minimum.	Raise the sound output level of the center speaker.
		The center channel mode is in NONE mode.	Select LARGE or SMALL.
Incorrect sound field program selection.		Select the appropriate program.	

	SYMPTOM	CAUSE	REMEDY
FM	FM stereo reception is noisy.	Because of the characteristics of FM stereo broadcasts, this is limited to cases where the transmitter is too far away or the antenna input is poor.	Check the antenna connections. Try using a high quality directional FM antenna. Set TUNING MODE to the manual tuning mode.
	There is distortion and clear reception cannot be obtained even with a good FM antenna.	There is multipath interference.	Adjust antenna placement to eliminate multipath interference.
	The desired station cannot be tuned in with the automatic tuning method.	The station is too weak.	Use the manual tuning method. Use a high quality directional FM antenna.
	Previously preset stations can no longer be tuned in.	This unit has been unplugged for a long period.	Repeat the presetting procedure.
AM	The desired station cannot be tuned in with the automatic tuning method.	Weak signal or loose antenna connections.	Tighten the AM loop antenna connections and rotate it for best reception. Use the manual tuning method.
	There are continuous crackling and hissing noises.	Noises will result from lightning, fluorescent lamps, motors, thermostats and other electrical equipment.	Use an outdoor antenna and a ground wire. This will help somewhat but it is difficult to eliminate all noise.
	There are buzzing and whining noises (especially in the evening).	A television set is being used nearby.	Relocate this unit away from the TV.
Remote control transmitter	The remote control transmitter does not work.	Direct sunlight or lighting (of an inverter type of fluorescent lamp etc.) is striking the remote control sensor of the main unit.	Change the position of the main unit.
		The manufacturer's code is not set properly.	Set the code again.
		The proper manufacturer's code for the component to be controlled is not set.	Try entering another code for the same manufacturer.
		The component to be controlled is not selected.	Set the SELECTOR DIAL to the proper position.
Others	The sound is degraded when listening with headphones to a CD player or tape deck that is connected to this unit.	This unit is in the standby mode.	Turn the power of the unit on.

SPECIFICATIONS

AUDIO SECTION

Minimum RMS Output Power
MAIN L/R
 8 ohms, 20 Hz to 20 kHz, 0.04% THD
 65 W + 65 W

CENTER
 8 ohms, 20 Hz to 20 kHz, 0.04% THD
 65 W

REAR L/R
 8 ohms, 20 Hz to 20 kHz, 0.04% THD
 65 W + 65 W

Dynamic Power per Channel
 (by IHF Dynamic Headroom measuring
 method)
 8/6/4/2 ohms 90/110/135/160 W

DIN Standard Output Power per Channel
 [Europe model only]
 4 ohms, 1 kHz, 0.7% THD 110 W

IEC Power
 [Europe model only]
 8 ohms, 1 kHz, 0.04% THD 75 W + 75 W

Power Band Width
 8 ohms, 35 W, 0.1% THD
 10 Hz to 50 kHz

Damping Factor (SPEAKERS A)
 8 ohms, 20 Hz to 20 kHz 60 or more

Input Sensitivity/Impedance
PHONO MM 2.5 mV/47 k-ohms
**CD/TAPE-MD/DVD-LD/TV-DBS/VCR/
 VIDEO AUX** 150 mV/47 k-ohms
EXT. DECODER
MAIN L/R 150 mV/47 k-ohms
CENTER/SURROUND L/R/SUBWOOFER
 150 mV/40 k-ohms

Maximum Input Signal
PHONO MM
 1 kHz, 0.1% THD 100 mV or more
**CD/TAPE-MD/DVD-LD/TV-DBS/VCR/
 VIDEO AUX (EFFECT ON)**
 1 kHz, 0.5% THD 2.2 V or more

Output Level/Impedance
REC OUT 150 mV/1.2 k-ohms
PRE OUT 2.1 V/1.2 k-ohms
SUBWOOFER
 (MAIN SP: SMALL) 4.0 V/1.2 k-ohms

Headphones Jack Rated Output/Impedance
**CD/TAPE-MD/DVD-LD/TV-DBS/VCR/
 VIDEO AUX input,**
 1 kHz, 150 mV, 8 ohms 0.5 V/390 ohms

Frequency Response (20 Hz to 20 kHz)
**CD/TAPE-MD/DVD-LD/TV-DBS/VCR/
 VIDEO AUX to MAIN L/R SP OUT**
 0±0.5 dB

RIAA Equalization Deviation
PHONO MM 0±0.5 dB

Total Harmonic Distortion (20 Hz to 20 kHz)
PHONO MM to REC OUT
 1 V 0.02% or less

Signal-to-Noise Ratio (IHF-A Network)
PHONO MM to REC OUT
 (5 mV, Input Shorted) 81 dB or more
**CD/TAPE-MD/DVD-LD/TV-DBS/VCR/
 VIDEO AUX to SP OUT (EFFECT OFF)**
 (150 mV, Input Shorted) 96 dB or more

Residual Noise (IHF-A Network)
MAIN L/R SP OUT 150 µV or less

Channel Separation
 (Vol. -30 dB, EFFECT OFF)
PHONO MM
 (Input Shorted, 1 kHz/10 kHz)
 60 dB or more/55 dB or more
**CD/TAPE-MD/DVD-LD/TV-DBS/VCR/
 VIDEO AUX**
 (Input 5.1 k-ohms Terminated, 1 kHz/10 kHz)
 60 dB or more/45 dB or more

Tone Control Characteristics
BASS: Boost/cut ±10 dB (50 Hz)
 Turnover Frequency 350 Hz
TREBLE: Boost/cut ±10 dB (20 kHz)
 Turnover Frequency 3.5 kHz

Filter Characteristics
MAIN L/R, REAR L/R (SPEAKER: SMALL)
 (H.P.F) fc = 90 Hz, 12 dB/oct.
SUBWOOFER
 (L.P.F) fc = 90 Hz, 18 dB/oct.

VIDEO SECTION

Video Signal Type PAL

Video Signal Level 1 Vp-p/75 ohms

S-Video Signal Level
Y 1 Vp-p/75 ohms
C 0.286 Vp-p/75 ohms

Maximum Input Level 1.5 Vp-p or more

Signal-to-Noise Ratio 50 dB or more

Monitor Out Frequency Response
 5 Hz to 10 MHz, -3 dB

FM SECTION

Tuning Range 87.5 to 108.0 MHz

Usable Sensitivity (75 ohms)
DIN, Mono (S/N 26 dB) 0.9 µV
DIN, Stereo (S/N 46 dB) 28 µV

Selectivity
 (two signals, 40 kHz Dev. ±300 kHz)
 55 dB

Signal-to-Noise Ratio
 (DIN-Weighted, 40 kHz Dev.)
Mono/Stereo 75 dB/69 dB

Harmonic Distortion (1 kHz)
Mono/Stereo 0.1/0.2%

Stereo Separation (1 kHz) 48 dB

Frequency Response
 20 Hz to 15 kHz 0±1 dB

Antenna Input 75 ohms, Unbalanced

Output Level
 (40 kHz Dev., 1 kHz) 550 mV

AM SECTION

Tuning Range 531 to 1,611 kHz

Usable Sensitivity 300 μ V/m

Signal-to-Noise Ratio 52 dB

Antenna Loop antenna

Output Level
(30% mod., 1 kHz) 150 mV

GENERAL

Power Supply AC 230 V, 50 Hz

Power Consumption 300 W

AC Outlets
2 SWITCHED OUTLETS
[Europe model] 100 W max. total
1 SWITCHED OUTLET
[U.K. model] 100 W max. total

Dimensions (W x H x D)
..... 435 x 151 x 391 mm
(17-1/8" x 5-15/16" x 15-3/8")

Weight 12.5 kg (27 lbs. 8 oz.)

Accessories AM loop antenna
Indoor FM antenna
75-ohm/300-ohm antenna adapter
(U.K. model only)
Remote control transmitter
Batteries

Specifications are subject to change without notice.

LIST OF MANUFACTURER'S CODES
LISTE DES CODES FABRICANTS
VERZEICHNIS DER HERSTELLER CODES
LISTA ÖVER TILLVERKARKODER
ELENCO DEI CODICI DEL FABBRICANTE
LISTA DE CÓDIGOS DE FABRICANTES
LIJST VAN CODES VAN FABRIKANT

TV					
Manufacturer	Code				
Abex	0032	Carrefour	0036	GPM	0218
Acura	0009	Cascade	0009	Geloso	0009, 0213
Admiral	0093, 0163, 0213	Cathay	0037	Genexxa	0218, 0163
Adyson	0217, 0032	Centurion	0037	GoldStar	0037, 0217, 0109, 0032, 0290
Akai	0208, 0361	Century	0213	Goodmans	0037, 0217, 0374, 0371, 0072, 0036, 0235, 0317, 0343
Akura	0218, 0264, 0369	Cimline	0009	Gorenje	0370
Alaron	0216	Clarivox	0037	Gradiente	0053
Alba	0037, 0218, 0371, 0009, 0036, 0235	Clatronic	0370, 0076, 0247	Graetz	0163, 0361
Allorgan	0294	Condor	0370, 0320	Granada	0037, 0217, 0072, 0146, 0208, 0339, 0359
Amplivision	0217	Contec	0216, 0009, 0036, 0157	Grandin	0282
Amstrad	0371, 0009, 0362, 0369	Continental Edison	0196, 0198, 0205, 0333	Grundig	0037, 0554, 0070, 0191, 0195, 0205
Anam	0009, 0068	Crosley	0074, 0076, 0084, 0213	HCM	0009, 0282
Anitech	0009, 0068, 0076	Crown	0037, 0370, 0418, 0009, 0076	Hanseatic	0037, 0320, 0361
Arcam	0216, 0217	Crystal	0431	Harley Davidson	0043
Asberg	0076	Curtis Mathes	0093	Harvard	0068
Asuka	0218	Cybertron	0218	Hinari	0037, 0218, 0009, 0036
Atlantic	0206	Daewoo	0037, 0374, 0009	Hisawa	0282, 0455
Audiosonic	0037, 0109	Dainichi	0218, 0215	Hitachi	0217, 0036, 0109, 0032, 0043, 0044, 0105, 0163, 0196, 0198, 0225, 0306, 0349
Autovox	0206, 0076, 0336	Dansai	0037	Huanyu	0216, 0374
BPL	0282	Dayton	0009	Hypson	0037, 0282, 0264
BSR	0294	De Graaf	0208	ICE	0217, 0371, 0264
BTC	0218	Decca	0037, 0072	ICeS	0218
Baird	0343	Dixi	0037, 0009	ITS	0371
Basic Line	0218, 0009	Dual	0336, 0352	ITT	0163, 0361
Baur	0037, 0010, 0554, 0349, 0361	Dual Tec	0217	Imperial	0370, 0418, 0074, 0076, 0084, 0247
Beko	0370	Dumont	0070	Indiana	0037
Beon	0037	Elbe	0259	Ingelen	0163
Binatone	0217	Elin	0037	Inno Hit	0072
Blaupunkt	0554, 0191, 0195, 0200, 0213, 0327, 0328	Elite	0218, 0320	Interbuy	0068
Blue Sky	0218	Elta	0009	Interfunk	0037, 0163, 0247, 0361
Blue Star	0282	Emerson	0282, 0213, 0361	Intervision	0037, 0217, 0264, 0102, 0068
Bondstec	0247	Erres	0037, 0012	Isukai	0218
Boots	0217	Expert	0206	JVC	0371, 0036, 0053, 0190, 0192
Brandt	0109, 0196, 0198, 0205, 0333, 0335	Ferguson	0037, 0109, 0005, 0073, 0190, 0238, 0287, 0335, 0343	KTV	0217
Brionvega	0362	Fidelity	0216, 0361	Kaisui	0216, 0217, 0218, 0009, 0282
Britannia	0216	Finlandia	0208, 0346, 0359	Kamp	0216
Bush	0037, 0218, 0374, 0371, 0294, 0009, 0282, 0036, 0349	Finlux	0037, 0072, 0070, 0105, 0346	Kapsch	0206, 0163
CCE	0037, 0217	Firstline	0216, 0217, 0294, 0009, 0321, 0247	Kawasho	0216
CGE	0074, 0076, 0084, 0247, 0306	Fisher	0370, 0217, 0208, 0303	Kendo	0037, 0235, 0362
CS Electronics	0216	Flint	0455	Kingsley	0216
CTC	0247	Formenti	0037, 0320, 0213	Kneissel	0259
		Frontech	0264, 0431, 0163, 0247		
		Fujitsu	0072, 0206		
		Funai	0294, 0264, 0303		
		GE	0282, 0093		
		GEC	0037, 0217, 0072, 0043, 0205		

Korpel	0037	Pathe Cinema	0216, 0320, 0213, 0238	Solavox	0032, 0163
Koyoda	0009	Pathe Marconi	0196, 0198, 0205, 0333	Sonitron	0208
Leyco	0037, 0294, 0072, 0264	Pausa	0009	Sonoko	0037, 0009
Liesenk & Tter	0037	Penney	0032	Sonolor	0163, 0208, 0215
Lloytron	0032	Perdio	0320	Sontec	0037
Loewe	0075	Phase	0032	Sony	0036, 0010, 0011
Luma	0206	Philco	0074, 0076, 0084, 0213, 0247	Soundwave	0037, 0418
Luxor	0349, 0361	Philips	0037, 0374, 0554, 0012, 0043, 0323	Standard	0217, 0218, 0009
M Electronic	0037, 0217, 0374, 0009, 0109, 0068, 0105, 0163, 0287, 0346	Phonola	0037, 0012	Stern	0206, 0163, 0259
MGA	0150	Pioneer	0109, 0163, 0287	Sunkai	0294, 0321
MTC	0216, 0349	Profex	0009, 0076, 0361	Susumu	0218
Magnadyne	0102, 0247	Proline	0321	Sysline	0037
Magnafon	0102, 0076, 0213	Protech	0037, 0217, 0418, 0009, 0264, 0102, 0431, 0247, 0337	Tandy	0217, 0218, 0072, 0093, 0163
Magnavox	0036	Pye	0012	Tashiko	0217, 0036, 0043, 0359
Manesth	0217, 0320, 0264, 0235	Quasar	0250	Tatung	0037, 0217, 0072
Marantz	0037	Quelle	0037, 0010, 0554, 0011, 0070, 0074, 0084, 0200, 0213, 0306, 0327, 0328, 0361	Tec	0217, 0247
Mark	0037	Questa	0036	Technema	0320
Matsui	0037, 0217, 0371, 0294, 0009, 0072, 0036, 0035, 0011, 0208, 0235	R-Line	0037	Technics	0250
Matsushita	0250	RBM	0070	Teknika	0150
McMichael	0043	RCA	0090, 0093	Teleavia	0205, 0333, 0343
Mediator	0037, 0012	Radio Shack	0032	Telefunken	0109, 0005, 0074, 0084, 0101, 0213, 0262, 0306, 0335, 0343
Memorex	0009, 0250, 0150	Radiola	0037, 0012, 0323	Telemeister	0320
Memphis	0337	Rank Arena	0036	Teletech	0009
Metz	0213, 0367	Realistic	0032	Teleton	0217, 0206, 0349
Midland	0032	Rediffusion	0361	Tensai	0218, 0294, 0320, 0317
Minerva	0554, 0070	Revox	0037	Texet	0216, 0218
Minoka	0369	Rex	0206, 0264, 0163, 0259	Thomson	0109, 0196, 0198, 0205, 0287, 0333, 0343, 0349
Mitsubishi	0036, 0093, 0108, 0150	Rhapsody	0216	Thorn	0037, 0072, 0035, 0074, 0084, 0190, 0192, 0361
Mivar	0216, 0290, 0291, 0292	Roadstar	0218, 0418, 0009, 0264	Thorn-Ferguson	0343
Motion	0076	SBR	0037, 0012, 0043	Tomashi	0282
Motorola	0093	SEG	0217, 0264, 0036, 0076	Toshiba	0036, 0035, 0070, 0243
Multitech	0216, 0217, 0009, 0102, 0076	SEI	0294, 0102, 0213	Trical	0157
NEC	0455, 0036	Saba	0109, 0075, 0163, 0196, 0198, 0205, 0213, 0287, 0335, 0343	Triumph	0243
NEI	0037, 0431, 0337	Sacccs	0238	Uher	0206, 0320, 0303
Neckermann	0037, 0554, 0191, 0213, 0349	Saisho	0009, 0264, 0431, 0011, 0235	Ultra	0192
Nikkai	0037, 0216, 0218, 0072, 0264, 0035, 0032, 0337	Salora	0163, 0349, 0359, 0361	Ultravox	0102
Nikko	0317	Sambers	0102, 0076, 0213	Universum	0037, 0370, 0264, 0105, 0346
Noblisko	0102, 0076	Sampo	0032	Vestel	0037
Nokia	0361	Samsung	0037, 0370, 0217, 0009, 0264, 0032, 0090, 0290	Victor	0053
Nordmende	0109, 0196, 0198, 0213, 0287, 0343	Sandra	0216	Videosat	0247
Oceanic	0163, 0215, 0361	Sanyo	0072, 0036, 0011, 0146, 0157, 0208, 0213, 0339	Videotechnic	0217
Optimus	0250	Schaub Lorenz	0361	Vidtech	0036
Optonica	0093	Schneider	0037, 0218, 0371, 0247, 0303, 0323, 0336, 0352	Vision	0320
Orion	0037, 0294, 0320, 0321, 0235	Sears	0146	Voxson	0163
Osaki	0217, 0218, 0072, 0264, 0032	Sei-Sinudyne	0010	Waltham	0217
Oso	0218	Seleco	0206, 0163, 0259, 0362	Watson	0037, 0320
Osume	0072, 0032, 0157	Sentra	0035	Watt Radio	0102
Otake	0317	Sharp	0036, 0093, 0157	Wega	0036
Otto Versand	0037, 0217, 0320, 0036, 0010, 0554, 0191, 0213, 0343, 0349	Shorai	0294	White Westinghouse	0037, 0216, 0320
Palladium	0370, 0418	Siarem	0102, 0213	Yoko	0037, 0217, 0264, 0431
Panama	0217, 0264	Siemens	0037, 0554, 0157, 0191, 0195, 0200, 0213, 0327, 0328	Zanussi	0206
Panasonic	0250, 0163, 0213, 0214, 0226, 0367	Silver	0036		
		Sinudyne	0294, 0102, 0213, 0235		

CABLE

Manufacturer Code

ABC	1003, 1008, 1014, 1017
Birmingham Cable Communications	1276
British Telecom	1003, 1105
Cabletime	1161, 1271, 1377
Clyde	1086
Contec	1019
Decsat	1423
Filmnet	1443
France Telecom	1451
GEC	1086
General Instrument	1276
GoldStar	1144
Jerrold	1003, 1276, 1014
MNet	1443, 1019
Magnavox	1032
Memorex	1000
Movie Time	1156
NSC	1156
Oak	1019
PVP Stereo Visual Matrix	1003
Panasonic	1000
Paragon	1000
Pioneer	1144, 1260
Pulsar	1000
Runco	1000
STS	1156
Salora	1382
Samsung	1144
Satbox	1375
Scientific Atlanta	1008, 1277, 1017
Starcom	1003
Tele+1	1443
Teleservice	1281
Toshiba	1000
Tudi	1286
United Cable	1003
Videoway	1250
Westminster	1105
Zenith	1000

DBS TUNER

Manufacturer Code

AST	2321, 2351
Alba	2455, 2421, 2362, 2613
Aldes	2288
Allantide	2333
Amstrad	2080, 2252, 2345, 2461, 2501
Ankaro	2369, 2288, 2220, 2519, 2217
Anttron	2421, 2183
Arcon	2368
Armstrong	2243
Astra	2108, 2539

Astro	2520, 2173, 2358, 2501
Avalon	2396
Axis	2369, 2530
BT	2668
Barcom	2217
Beko	2189
Best	2369, 2217
Blaupunkt	2173
Boca	2243, 2513
Brain Wave	2332
Bush	2067
CNT	2520
Cambridge	2344
Channel Master	2362
Chaparral	2053, 2209
CityCom	2394
CommLink	2288
Connexions	2396
Crown	2243
Cyrus	2200
D-box	2723
DDC	2362
DNT	2396, 2200
Diskxpress	2217
Drake	2268
EIF	2417
Echostar	2396, 2871
Emanon	2421
FTE	2331
Ferguson	2183, 2067, 2189, 2336
Fidelity	2252
Finlux	2455, 2108, 2344, 2397
Fracarro	2871
Freecom	2421, 2335
Fuba	2421, 2369, 2396, 2217, 2297, 2417
G-Sat	2183
Galaxis	2288, 2834, 2863
Galaxisat	2321
GoldStar	2335
Gooding	2571
Goodmans	2189
Grothusen	2335
Grundig	2571, 2173, 2189, 2328
Harting und Helling	2333
Hinari	2183
Hirschmann	2502, 2173, 2573, 2287, 2333, 2397, 2398
Hitachi	2455
Houston	2668
Huth	2243, 2288, 2220, 2346
ITT	2108
InVideo	2871
Intervision	2592
JVC	2571
Johansson	2332
Kathrein	2173, 2200, 2092, 2331, 2358, 2394, 2442, 2480, 2504
Kosmos	2331, 2335
Kreiselmeier	2173

Kyostar	2421
La Sat	2520, 2513, 2464
Lemon	2692
Lenco	2421, 2335
Lennox	2592
Lupus	2369
Luxor	2573, 2108
Manhattan	2455, 2592, 2520
Marantz	2200
Maspro	2092, 2328, 2336
Matsui	2571, 2344
Mediamarkt	2243
Micro Technology	2333, 2539
Minerva	2571
Morgan's	2243, 2513
Multistar	2331, 2464
Muratto	2335
Navex	2332
Neuhaus	2501
Neusat	2692, 2834
Newhaus	2220
Nikko	2360
Nokia	2455, 2573, 2108, 2328, 2397, 2873
Nordmende	2362
Orbitech	2501
Oxford	2344
Pace	2455, 2183, 2067, 2328, 2336, 2791
Palcom	2297
Palladium	2571
Palsat	2501
Panda	2455
Philips	2455, 2571, 2200, 2292, 2328
Phonotrend	2288, 2592
Planet	2871
Plasmatic	2442
Polytron	2394
Promax	2455
Prosat	2288
Quadral	2362, 2519
RFT	2288, 2220, 2200
Radiola	2200
Radix	2396, 2882
SAT	2321, 2351, 2461
SEG	2421, 2369, 2539
STVI	2417
Saba	2520, 2336
Sabre	2455
Sagem	2820
Salora	2108
Samsung	2287
SatPartner	2421, 2332, 2520, 2502, 2335, 2692
Satcom	2605, 2346
Satec	2183, 2328
Satmaster	2346
Schwaiger	2183, 2394, 2504
Seemann	2396, 2530
Siemens	2173

Skymaster	2288, 2605, 2519	CGE	3000	Hanseatic	3037
Star Trak	2421	Calix	3037	Harley Davidson	3000
Strong	2421	Capehart	3020	Harman/Kardon	3038
Sunstar	2513	Carver	3081	Harwood	3072
TPS	2820	Catron	3020	Headquarter	3046
Tantec	2455, 2297, 2336	Cimline	3072	Hinari	3072, 3004, 3240, 3352
TechniSat	2262, 2501	Cineral	3278	Hitachi	3000, 3004, 3042, 3041, 3166, 3235, 3240
Techniland	2346	Citizen	3037, 3278	Hypson	3072
Telefunken	2421	Clatronic	3020	ITT	3106, 3046, 3384, 3005, 3041, 3104, 3240
Teleka	2243, 2613	Colt	3072	ITV	3037, 3278
Telesat	2605	Combitech	3352	Imperial	3000
Thomson	2455	Condor	3020	Ingersol	3004
Tonna	2668, 2346	Craig	3072, 3037, 3047, 3240	Interfunk	3081
Triad	2321, 2333, 2335, 2351	Crown	3072, 3020, 3278	JVC	3067, 3384, 3008, 3041, 3206, 3207, 3486
Triasat	2501	Curtis Mathes	3041, 3162	Jensen	3041
Unitor	2332, 2217	Cybernex	3240	KEC	3037, 3278
Universum	2571, 2173	Cyrus	3081	KLH	3072
Vector	2333	Daewoo	3020, 3278, 3045	Kaisui	3072
Ventana	2200	Dansai	3072	Kendo	3209, 3106
Vortec	2421	Daytron	3020	Kenwood	3067, 3384, 3038, 3041
Vtech	2351	De Graaf	3042, 3166	Kodak	3037
Wevasat	2333	Decca	3000, 3081	Korpel	3072
Winersat	2332	Denon	3042	LXI	3037
Wisi	2455, 2396, 2173, 2321, 2351, 2372, 2406, 2407	Dual	3041	Lenco	3278
XSat	2889	Dumont	3000, 3081, 3104	Leyco	3072
Xcom Multimedia	2889	Dynatech	3000	Lloyd's	3000
Zehnder	2520, 2321, 2331	ESC	3278, 3240	Loewe	3037, 3004, 3081, 3006
		Elbe	3038	Logik	3072, 3004, 3240
		Elcatech	3072	Luxor	3106, 3048, 3046, 3043, 3104
		Electrohome	3037	M Electronic	3000
		Electroponic	3037	MGA	3043, 3240
		EmereX	3032	MGN Technology	3240
		Emerson	3000, 3037, 3278, 3209, 3036, 3043, 3088	MTC	3000, 3240
		Ferguson	3320, 3041, 3107, 3321	Magnasonic	3278
		Fidelity	3000	Magnavox	3000, 3081
		Finlandia	3081, 3104	Magnin	3240
		Finlux	3000, 3081, 3042, 3104	Manesth	3072, 3045
		Firstline	3072, 3037, 3209, 3045, 3043	Marantz	3081, 3003, 3006
		Fisher	3046, 3047, 3054, 3104	Marta	3037
		Frontech	3020	Matsui	3209, 3004, 3036, 3088, 3348, 3352
		Fuji	3033	Matsushita	3162
		Funai	3000	Memorex	3000, 3037, 3048, 3046, 3047, 3104, 3162, 3240, 3307
		GE	3048, 3240	Memphis	3072
		GEC	3081	Metz	3347, 3195, 3003, 3006, 3162, 3227
		Garrard	3000	Minerva	3195, 3006
		General	3020	Minolta	3042
		Go Video	3432	Mitsubishi	3081, 3067, 3048, 3043
		GoldHand	3072	Motorola	3048
		GoldStar	3037, 3038, 3225	Multitech	3072, 3000
		Goodmans	3072, 3000, 3020, 3037, 3278, 3403	Murphy	3000
		Gradiente	3000, 3008	NEC	3067, 3038, 3041, 3104
		Graetz	3005, 3041, 3104, 3240	Neckermann	3081
		Granada	3081, 3046, 3104	Nesco	3072
		Grandin	3072, 3000, 3037	Nikko	3037
		Grundig	3072, 3081, 3347, 3226, 3195, 3003, 3006, 3007, 3207, 3349, 3403	Nikon	3034
		HCM	3072		
		HI-Q	3047		

VCR

Manufacturer	Code
ASA	3037, 3081
Admiral	3048
Adventura	3000
Aiko	3278
Aiwa	3000, 3037, 3307, 3348, 3352
Akai	3315, 3106, 3041, 3053
Akiba	3072
Alba	3072, 3020, 3278, 3209, 3315, 3352
Ambassador	3020
Amstrad	3000, 3278, 3325, 3332
Anitech	3072
Asha	3240
Asuka	3037
Audiovox	3037
Baird	3000, 3041, 3104, 3107
Basic Line	3072, 3020, 3278
Beaumarck	3240
Bell & Howell	3104
Blaupunkt	3034, 3226, 3195, 3003, 3006, 3154, 3162, 3227, 3403
Brandt	3320, 3187, 3321
Brandt Electronic	3041
Broksonic	3209
Bush	3072, 3278, 3209, 3352
CCE	3072, 3278

Noblex	3240	Sears	3000, 3037, 3042, 3046, 3047, 3054, 3104
Nokia	3106, 3046, 3041, 3104, 3240	Selec	3041
Nordmende	3320, 3384, 3041, 3297, 3321	Semp	3045
Oceanic	3000, 3041	Senra	3020
Okano	3315, 3348	Sharp	3048
Olympus	3226	Shintom	3072, 3104
Optimus	3037, 3432, 3048, 3104, 3162	Shogun	3240
Orion	3209, 3004, 3036, 3088, 3348, 3352	Shorai	3004
Osaki	3072, 3000, 3037	Siemens	3037, 3081, 3195, 3003, 3006, 3054, 3104
Otto Versand	3081	Silva	3037
Palladium	3072, 3037, 3006, 3041	Singer	3072, 3045
Panasonic	3226, 3162, 3225, 3227	Sinudyne	3004, 3081
Pathe Cinema	3036	Solavox	3020
Pathe Marconi	3041	Sonor	3046
Penney	3037, 3042, 3038, 3054, 3240	Sontec	3037
Pentax	3042	Sony	3000, 3032, 3033, 3034, 3011
Perdio	3000	Sunkai	3348
Philco	3209, 3038	Sunstar	3000
Philips	3081, 3384, 3403	Suntronic	3000
Phonola	3081	Sylvania	3000, 3081, 3043
Pilot	3037	Symphonic	3000
Pioneer	3081, 3067, 3162, 3235	TMK	3036, 3240
Portland	3020	Tashiko	3000
Profex	3322	Tatung	3000, 3081, 3041
Profitronic	3240	Teac	3000, 3041
Proline	3000	Tec	3020
Protec	3072	Technics	3226, 3162
Pye	3081	Teknika	3000, 3037
Quarter	3046	Teleavia	3041
Quartz	3046	Telefunken	3320, 3384, 3041, 3187, 3321
Quasar	3162	Tenosal	3072
Quelle	3081	Tensai	3322, 3000
RCA	3106, 3042, 3048, 3240	Thomas	3000
RFT	3403	Thomson	3320, 3384, 3041
Radio Shack	3000, 3037	Thorn	3036, 3041, 3104
Radiola	3081	Toshiba	3081, 3045, 3384, 3041, 3043
Radix	3037	Totevision	3037, 3240
Randex	3037	Towada	3322
Realistic	3000, 3037, 3048, 3046, 3047, 3104	Uher	3240
Rex	3384, 3041	Unitech	3240
Ricoh	3034	Universum	3000, 3037, 3081, 3106, 3195, 3006, 3240, 3325
Roadstar	3072, 3037, 3278, 3240	Vector	3045
SBR	3081	Vector Research	3038
SEG	3322, 3240	Video Concepts	3045
SEI	3004, 3081	Videosonic	3240
STS	3042	Wards	3072, 3000, 3081, 3042, 3048, 3047, 3240
Saba	3320, 3384, 3041, 3206, 3207, 3297, 3321	White Westinghouse	3278
Saisho	3209, 3004, 3036, 3088	XR-1000	3072, 3000
Salora	3106, 3046, 3043	Yamaha	3038
Samsung	3432, 3045, 3053, 3240	Yamishi	3072
Sanky	3048	Yokan	3072
Sansui	3000, 3067, 3041	Yoko	3020, 3240
Sanyo	3046, 3047, 3104, 3240	Zenith	3000, 3033, 3034
Saville	3352		
Schaub Lorenz	3000, 3005, 3041, 3104		
Schneider	3072, 3000, 3081		
Scott	3045, 3043		

DVD PLAYER

Manufacturer	Code
Kenwood	4534
Magnavox	4503
Onkyo	4503
Panasonic	4490
Philips	4539, 4503
Pioneer	4525
Sony	4533
Technics	4490
Thomson	4551
Toshiba	4503
Yamaha	4490, 4545
Zenith	4503

LD PLAYER

Manufacturer	Code
Aiwa	5203
Carver	5064, 5194
Cyrus	5388
Denon	5059, 5172
Disco Vision	5023
Funai	5203
Hitachi	5023
Magnavox	5194, 5217
Marantz	5064, 5194
Mitsubishi	5059
NAD	5059
Panasonic	5204, 5496
Philips	5064, 5388, 5194
Pioneer	5023, 5059
Quasar	5204
Radiola	5388
Realistic	5203
Salora	5064
Sega	5023
Sharp	5001
Sony	5193, 5201
Technics	5204, 5496
Telefunken	5059
Theta Digital	5194
Thorn	5014
Yamaha	5217

CD PLAYER

Manufacturer	Code
Aiwa	6124, 6157, 6419
Akai	6108, 6156, 6199
Alba	6536, 6288, 6334
Arcam	6157
Audio Research	6157
Audio Ton	6157
Audiolab	6157
Audiomeca	6157
BSR	6134
Bestar	6164
Binatone	6452
California Audio Lab	6029
Carver	6157, 6179
Condor	6134, 6164
Cyrus	6157
DKK	6000
Denon	6003, 6034
Dual	6196
Emerson	6164
Fisher	6048, 6179, 6342
GE	6334
Genexxa	6032, 6164
GoldStar	6525, 6383
Goodmans	6536
Grundig	6157
Harman/Kardon	6108, 6173
Hitachi	6032, 6291
JVC	6072
Kenwood	6037, 6523, 6028, 6048, 6190
Kodak	6287
Krell	6157
Linn	6157
Luxman	6328
M Electronic	6525
MCS	6029
Magnavox	6157, 6038, 6129
Marantz	6157, 6029, 6038, 6129
Matsui	6157, 6288, 6307
McIntosh	6287

Memorex	6032, 6164
Meridian	6157
Micromega	6157
Mission	6157
Mitsubishi	6108, 6156
NAD	6000
NSM	6157
Naim	6157
Nikko	6525, 6164
Onkyo	6101, 6102
Optimus	6000, 6032, 6037, 6536, 6048, 6179, 6196, 6342
Panasonic	6303, 6029, 6367
Philips	6157, 6274, 6287
Pioneer	6032
Poppy	6164
Proton	6157
QED	6157
Quad	6157
Quasar	6029
RCA	6179
Realistic	6164, 6179
Revox	6157, 6113
Roadstar	6461, 6525, 6527
Rotel	6157
SAE	6157
Sansui	6157, 6202, 6513
Sanyo	6048, 6179, 6342
Schneider	6134
Scott	6164
Sharp	6037, 6262, 6265
Sherwood	6114, 6196
Siemens	6516
Signature	6108
Sony	6000, 6490
Teac	6378
Technics	6207, 6303, 6029
Toshiba	6481
Universum	6157
Victor	6072
Wards	6157, 6108
Yamaha	6036, 6082, 6187, 6712
Yorx	6461

MD RECORDER

Manufacturer	Code
Kenwood	7826
Sony	7490
Yamaha	7888, 7490

TAPE DECK

Manufacturer	Code
Aiwa	8029, 8197, 8200
Akai	8188, 8189
Arcam	8076
Carver	8029
Denon	8076, 8412
Fisher	8074
Grundig	8029
Harman/Kardon	8182
JVC	8244, 8273, 8274
Kenwood	8070, 8071, 8092, 8205, 8233, 8234
Magnavox	8029
Marantz	8029, 8009
Memorex	8099, 8101
Mitsubishi	8189
Onkyo	8136, 8135
Optimus	8027, 8220
Panasonic	8229
Philips	8029
Pioneer	8027, 8099, 8101, 8220
Revox	8029
Sansui	8029, 8009
Sanyo	8074
Sharp	8205
Sony	8170, 8243
Technics	8229
Victor	8273, 8274
Wards	8027
Yamaha	8094, 8097, 8205, 8478, 8524



YAMAHA ELECTRONICS CORPORATION, USA 6660 ORANGETHORPE AVE., BUENA PARK, CALIF. 90620, U.S.A.
YAMAHA CANADA MUSIC LTD. 135 MILNER AVE., SCARBOROUGH, ONTARIO M1S 3R1, CANADA
YAMAHA ELECTRONIK EUROPA G.m.b.H. SIEMENSSTR. 22-34, 25462 RELINGEN BEI HAMBURG, F.R. OF GERMANY
YAMAHA ELECTRONIQUE FRANCE S.A. RUE AMBROISE CROIZAT BP70 CROISSY-BEAUBOURG 77312 MARNE-LA-VALLEE CEDEX02, FRANCE
YAMAHA ELECTRONICS (UK) LTD. YAMAHA HOUSE, 200 RICKMANSWORTH ROAD WATFORD, HERTS WD1 7JS, ENGLAND
YAMAHA SCANDINAVIA A.B. J A WETTERGRENS GATA 1, BOX 30053, 400 43 VÄSTRA FRÖLUNDA, SWEDEN
YAMAHA MUSIC AUSTRALIA PTY, LTD. 17-33 MARKET ST., SOUTH MELBOURNE, 3205 VIC., AUSTRALIA

YAMAHA CORPORATION
Printed in France ID V296030

Quick Reference Card

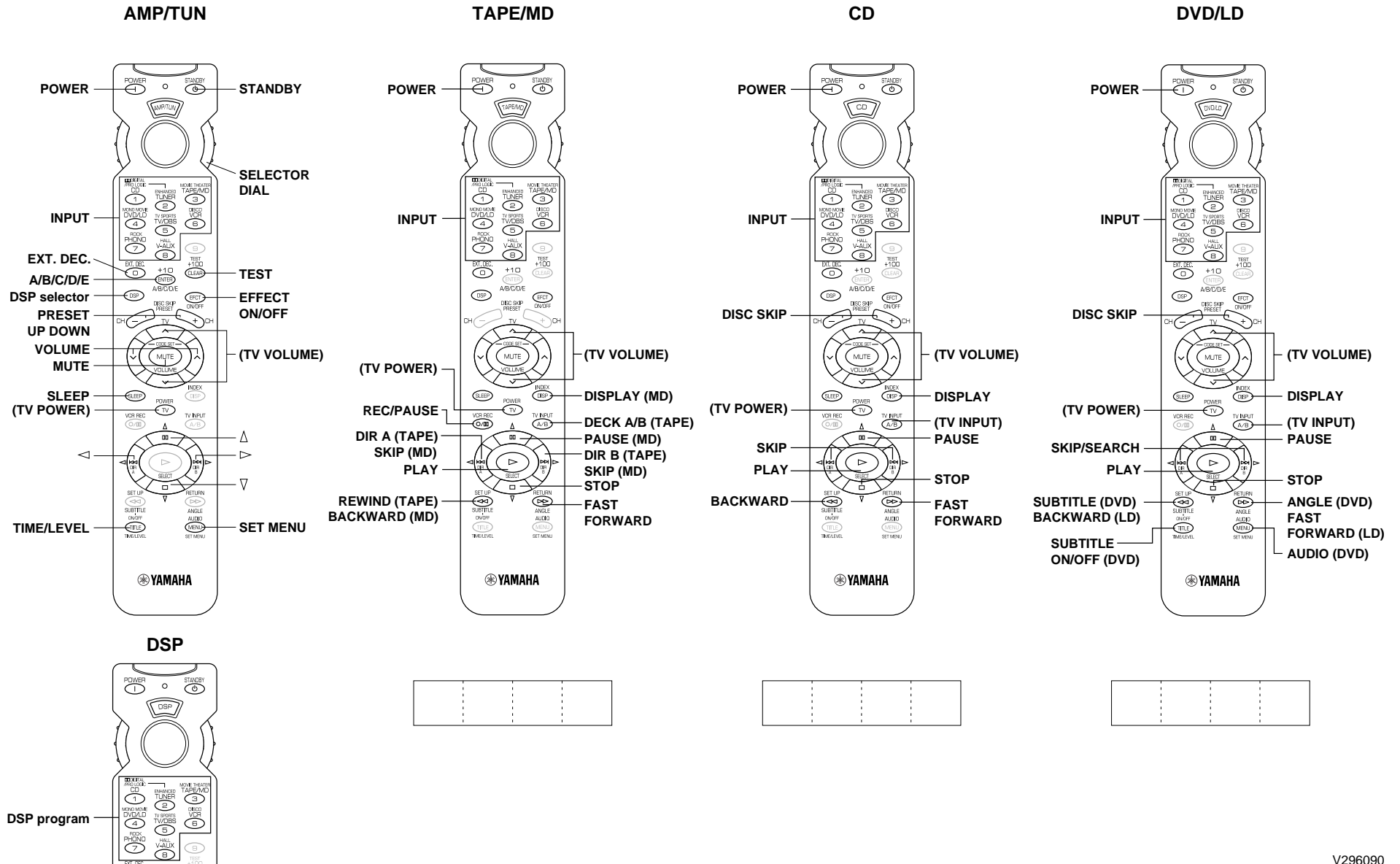

Quick Reference Card

AMP/TUN

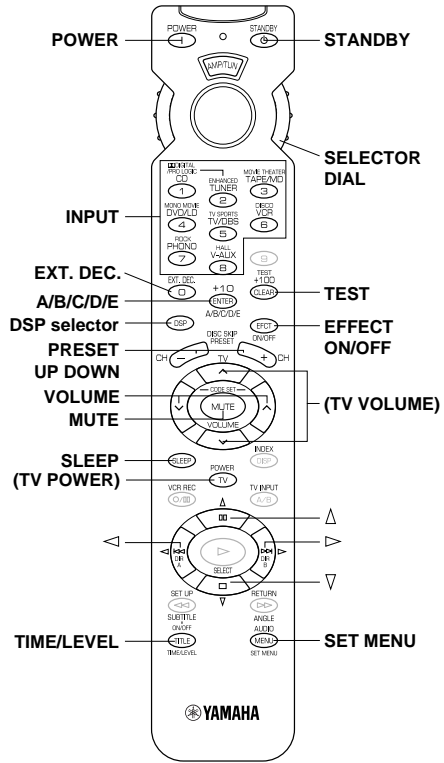

TAPE/MD

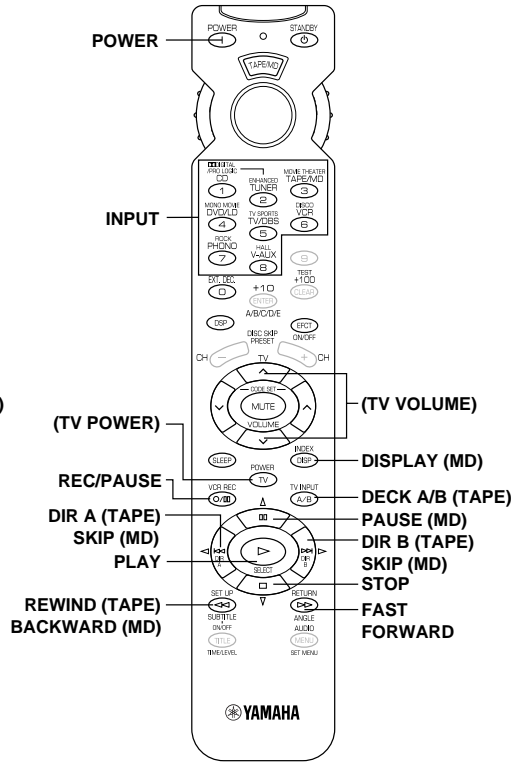

CD

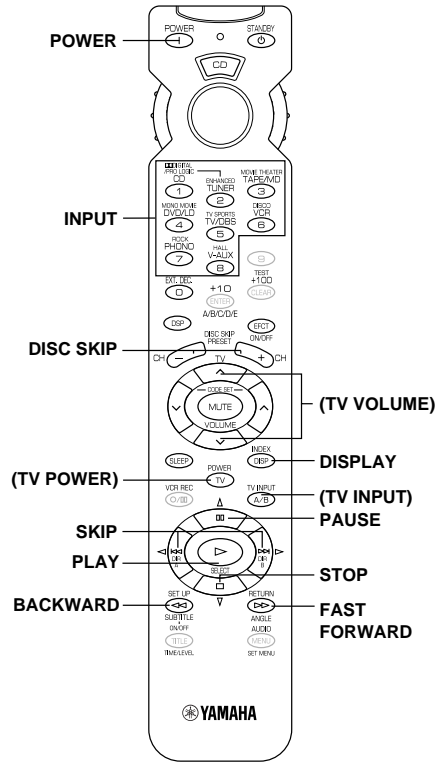

DVD/LD

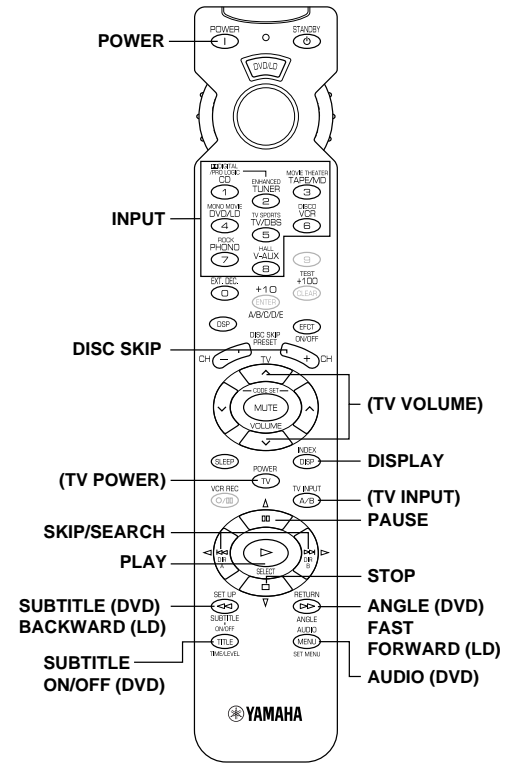

DSP

