



# Restio

ISX-18 / ISX-18 D  
INTEGRATED AUDIO SYSTEM



musicCast

OWNER'S MANUAL

Before using this unit, be sure to read the "Safety Brochure" and "Quick Manual."

# IMPORTANT SAFETY INSTRUCTIONS

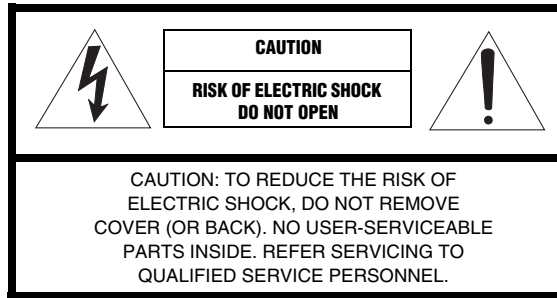

## • Explanation of Graphical Symbols

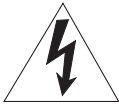

The lightning flash with arrowhead symbol, within an equilateral triangle, is intended to alert you to the presence of uninsulated “dangerous voltage” within the product’s enclosure that may be of sufficient magnitude to constitute a risk of electric shock to persons.



The exclamation point within an equilateral triangle is intended to alert you to the presence of important operating and maintenance (servicing) instructions in the literature accompanying the appliance.

- 1 Read these instructions.
- 2 Keep these instructions.
- 3 Heed all warnings.
- 4 Follow all instructions.
- 5 Do not use this apparatus near water.
- 6 Clean only with dry cloth.
- 7 Do not block any ventilation openings. Install in accordance with the manufacturer’s instructions.
- 8 Do not install near any heat sources such as radiators, heat registers, stoves, or other apparatus (including amplifiers) that produce heat.
- 9 Do not defeat the safety purpose of the polarized or grounding-type plug. A polarized plug has two blades with one wider than the other. A grounding type plug has two blades and a third grounding prong. The wide blade or the third prong are provided for your safety. If the provided plug does not fit into your outlet, consult an electrician for replacement of the obsolete outlet.
- 10 Protect the power cord from being walked on or pinched particularly at plugs, convenience receptacles, and the point where they exit from the apparatus.
- 11 Only use attachments/accessories specified by the manufacturer.

- 12 Use only with the cart, stand, tripod, bracket, or table specified by the manufacturer, or sold with the apparatus. When a cart is used, use caution when moving the cart/apparatus combination to avoid injury from tip-over.
- 13 Unplug this apparatus during lightning storms or when unused for long periods of time.
- 14 Refer all servicing to qualified service personnel. Servicing is required when the apparatus has been damaged in any way, such as power-supply cord or plug is damaged, liquid has been spilled or objects have fallen into the apparatus, the apparatus has been exposed to rain or moisture, does not operate normally, or has been dropped.



## We Want You Listening For A Lifetime



Yamaha and the Electronic Industries Association’s Consumer Electronics Group want you to get the most out of your equipment by playing it at a safe level. One that lets the sound come through loud and clear without annoying blaring or distortion – and, most importantly, without affecting your sensitive hearing.

Since hearing damage from loud sounds is often undetectable until it is too late, Yamaha and the Electronic Industries Association’s Consumer Electronics Group recommend you to avoid prolonged exposure from excessive volume levels.

## FCC INFORMATION (for US customers)

### 1 **IMPORTANT NOTICE: DO NOT MODIFY THIS UNIT!**

This product, when installed as indicated in the instructions contained in this manual, meets FCC requirements. Modifications not expressly approved by Yamaha may void your authority, granted by the FCC, to use the product.

2 **IMPORTANT:** When connecting this product to accessories and/or another product use only high quality shielded cables. Cable/s supplied with this product **MUST** be used. Follow all installation instructions. Failure to follow instructions could void your FCC authorization to use this product in the USA.

3 **NOTE:** This product has been tested and found to comply with the requirements listed in FCC Regulations, Part 15 for Class “B” digital devices. Compliance with these requirements provides a reasonable level of assurance that your use of this product in a residential environment will not result in harmful interference with other electronic devices.

This equipment generates/uses radio frequencies and, if not installed and used according to the instructions found in the users manual, may cause interference harmful to the operation of other electronic devices.

Compliance with FCC regulations does not guarantee that interference will not occur in all installations.

If this product is found to be the source of interference, which can be determined by turning the unit “OFF” and “ON”, please try to eliminate the problem by using one of the following measures:

Relocate either this product or the device that is being affected by the interference.

Utilize power outlets that are on different branch (circuit breaker or fuse) circuits or install AC line filter/s.

In the case of radio or TV interference, relocate/reorient the antenna. If the antenna lead-in is 300 ohm ribbon lead, change the lead-in to coaxial type cable.

If these corrective measures do not produce satisfactory results, please contact the local retailer authorized to distribute this type of product. If you can not locate the appropriate retailer, please contact Yamaha Corporation of America A/V Division, 6600 Orangethorpe Avenue, Buena Park, CA 90620.

The above statements apply **ONLY** to those products distributed by Yamaha Corporation of America or its subsidiaries.

This device complies with part 15 of FCC Rules and Industry Canada’s licence-exempt RSSs. Operation is subject to the following two conditions: (1) this device may not cause harmful interference, and (2) this device must accept any interference received, including interference that may cause undesired operation.

### FCC CAUTION

Change or modifications not expressly approved by the party responsible for compliance could void the user’s authority to operate the equipment.

### FOR CANADIAN CUSTOMERS

To prevent electric shock, match wide blade of plug to wide slot and fully insert.  
CAN ICE-3 (B)/NMB-3 (B)

### IMPORTANT

Please record the serial number of this unit in the space below.

MODEL:

Serial No.:

The serial number is located on the rear of the unit. Retain the Owner’s Manual in a safe place for future reference.

### COMPLIANCE INFORMATION STATEMENT

Responsible Party: Yamaha Corporation of America A/V Division

Address: 6600 Orangethorpe Avenue, Buena Park, CA 90620

Telephone: 714-522-9011

Type of Equipment: Integrated Audio System

Model Name: ISX-18

This device complies with Part 15 of FCC Rules and Industry Canada licence-exempt RSS standard(s).

Operation is subject to the following two conditions:

- (1) this device may not cause interference, and
- (2) this device must accept any interference, including interference that may cause undesired operation of this device.

### NOTICE

This equipment has been tested and found to comply with the limits for a Class B digital device, pursuant to part 15 of the FCC Rules. These limits are designed to provide reasonable protection against harmful interference in a residential installation.

This equipment generates, uses and can radiate radio frequency energy and, if not installed and used in accordance with the instructions, may cause harmful interference to radio communications.

However, there is no guarantee that interference will not occur in a particular installation. If this equipment does cause harmful interference to radio or television reception, which can be determined by turning the equipment off and on, the user is encouraged to try to correct the interference by one or more of the following measures:

- Reorient or relocate the receiving antenna.
- Increase the separation between the equipment and receiver.
- Connect the equipment into an outlet on a circuit different from that to which the receiver is connected.
- Consult the dealer or an experienced radio/TV technician for help.

This equipment complies with FCC/IC radiation exposure limits set forth for an uncontrolled environment and meets the FCC radio frequency (RF) Exposure Guidelines and RSS-102 of the IC radio frequency (RF) Exposure rules. This equipment should be installed and operated keeping the radiator at least 20cm or more away from person’s body.

This transmitter must not be co-located or operated in conjunction with any other antenna or transmitter.

# CAUTION: READ THIS BEFORE OPERATING YOUR UNIT.

- 1 To assure the finest performance, please read this manual carefully. Keep it in a safe place for future reference.
- 2 Install this sound system in a well ventilated, cool, dry, clean place - away from direct sunlight, heat sources, vibration, dust, moisture, and/or cold. For proper ventilation, allow the following minimum clearances.  
Top: 5 cm (2 in.), Rear: 5 cm (2 in.), Sides: 5 cm (2 in.)
- 3 Locate this unit away from other electrical appliances, motors, or transformers to avoid humming sounds.
- 4 Do not expose this unit to sudden temperature changes from cold to hot, and do not locate this unit in an environment with high humidity (i.e. a room with a humidifier) to prevent condensation inside this unit, which may cause an electrical shock, fire, damage to this unit, and/or personal injury.
- 5 Avoid installing this unit where foreign object may fall onto this unit and/or this unit may be exposed to liquid dripping or splashing. On the top of this unit, do not place:
  - Other components, as they may cause damage and/or discoloration on the surface of this unit.
  - Burning objects (i.e. candles), as they may cause fire, damage to this unit, and/or personal injury.
  - Containers with liquid in them, as they may fall and liquid may cause electrical shock to the user and/or damage to this unit.
- 6 Do not cover this unit with a newspaper, tablecloth, curtain, etc. in order not to obstruct heat radiation. If the temperature inside this unit rises, it may cause fire, damage to this unit, and/or personal injury.
- 7 Do not plug in this unit to a wall outlet until all connections are complete.
- 8 Do not operate this unit upside-down. It may overheat, possibly causing damage.
- 9 Do not use force on switches, knobs and/or cords.
- 10 When disconnecting the power cable from the wall outlet, grasp the plug; do not pull the cable.
- 11 Do not clean this unit with chemical solvents; this might damage the finish. Use a clean, dry cloth.
- 12 Only voltage specified on this unit must be used. Using this unit with a higher voltage than specified is dangerous and may cause fire, damage to this unit, and/or personal injury. Yamaha will not be held responsible for any damage resulting from use of this unit with a voltage other than specified.
- 13 To prevent damage by lightning, keep the power cable and outdoor antennas disconnected from a wall outlet or this unit during a lightning storm.
- 14 Do not attempt to modify or fix this unit. Contact qualified Yamaha service personnel when any service is needed. The cabinet should never be opened for any reasons.
- 15 When not planning to use this unit for long periods of time (i.e. vacation), disconnect the AC power plug from the wall outlet.
- 16 Be sure to refer to the “Troubleshooting” section for common operating errors before concluding that this unit is faulty.
- 17 Before moving this unit, press  to set it to standby mode and disconnect the AC power plug from the wall outlet.
- 18 Condensation will form when the surrounding temperature changes suddenly. Disconnect the power cable from the outlet, then leave this unit alone.
- 19 When using this unit for a long time, this unit may become warm. Turn the power off, then leave this unit alone for cooling.
- 20 Install this unit near the AC outlet and where the AC power plug can be reached easily.

- 21 Be sure to use the supplied AC adaptor. Also, do not use the supplied AC adaptor for other units. Failure to observe the above may cause a fire, burns, or malfunctions.

## WARNING

TO REDUCE THE RISK OF FIRE OR ELECTRIC SHOCK, DO NOT EXPOSE THIS UNIT TO RAIN OR MOISTURE.

This unit is not disconnected from the AC power source as long as it is connected to the wall outlet, even if this unit itself is turned off by . This state is called the standby mode. In this state, this unit is designed to consume a very small quantity of power.

Radio waves may affect electro-medical devices. Do not use this unit near medical devices or inside medical facilities.

Do not use this unit within 22 cm (9 inches) of persons with a heart pacemaker implant or defibrillator implant.

The user shall not reverse engineer, decompile, alter, translate or disassemble the software used in this unit, whether in part or in whole. For corporate users, employees of the corporation itself as well as its business partners shall observe the contractual bans stipulated within this clause. If the stipulations of this clause and this contract cannot be observed, the user shall immediately discontinue using the software.

#### ■ For U.K. customers

If the socket outlets in the home are not suitable for the plug supplied with this appliance, it should be cut off and an appropriate 3 pin plug fitted. For details, refer to the instructions described below.

#### **Note**

The plug severed from the mains lead must be destroyed, as a plug with bared flexible cord is hazardous if engaged in a live socket outlet.

#### ■ Special Instructions for U.K. Model

##### **IMPORTANT**

THE WIRES IN MAINS LEAD ARE COLOURED IN ACCORDANCE WITH THE FOLLOWING CODE:

Blue: NEUTRAL

Brown: LIVE

As the colours of the wires in the mains lead of this apparatus may not correspond with the coloured markings identifying the terminals in your plug, proceed as follows:

The wire which is coloured BLUE must be connected to the terminal which is marked with the letter N or coloured BLACK. The wire which is coloured BROWN must be connected to the terminal which is marked with the letter L or coloured RED.

Making sure that neither core is connected to the earth terminal of the three pin plug.

#### **Information for Users on Collection and Disposal of Old Equipment:**



This symbol on the products, packaging, and/or accompanying documents means that used electrical and electronic products should not be mixed with general household waste.

For proper treatment, recovery and recycling of old products, please take them to applicable collection points, in accordance with your national legislation.

By disposing of these products correctly, you will help to save valuable resources and prevent any potential negative effects on human health and the environment which could otherwise arise from inappropriate waste handling.

For more information about collection and recycling of old products, please contact your local municipality, your waste disposal service or the point of sale where you purchased the items.

#### **For business users in the European Union:**

If you wish to discard electrical and electronic equipment, please contact your dealer or supplier for further information.

#### **Information on Disposal in other Countries outside the European Union:**

This symbol is only valid in the European Union. If you wish to discard these items, please contact your local authorities or dealer and ask for the correct method of disposal.

#### **SIMPLIFIED EU DECLARATION OF CONFORMITY**

Hereby, Yamaha Music Europe GmbH declares that the radio equipment type [ISX-18D] is in compliance with Directive 2014/53/EU. The full text of the EU declaration of conformity is available at the following internet address:

<https://europe.yamaha.com/en/support/compliance/doc.html>

The name plate is located on the bottom of the unit.

# Table of Contents

---

## IMPORTANT SAFETY INSTRUCTIONS.....i

## CAUTION: READ THIS BEFORE OPERATING YOUR UNIT.....iii

## Introduction.....3

Supplied accessories.....3  
About this manual.....3

## Home audio network with MusicCast.....4

Easy control with the app.....4  
What you can do with this unit.....5

## Part name.....6

Top panel.....6  
Rear panel.....6  
Front panel display.....7

## Preparations.....8

Installation.....8  
Connecting the FM antenna (ISX-18) or DAB/FM antenna (ISX-18D).....9  
Connecting AC adaptor.....10  
Turning on the power.....11  
Connecting to the network.....12  
Setting of the devices and playback.....13  
Connecting to the network by sharing the iOS device setting.....14

## Playing network contents.....15

Listening to the songs in the computer.....15

Listening to Internet radio.....17  
Supports streaming services.....17  
Presetting network contents.....18

## Listening to the Music with AirPlay.....19

Playing back songs with iPhone.....19  
Playing back songs with iTunes.....19

## Listening to music via **Bluetooth** connection.....20

Pairing a **Bluetooth** device with the unit.....20  
Connecting a paired **Bluetooth** device and playing back music.....21  
Listening to music through wireless headphones.....22

## Listening to FM radio stations.....23

Tuning in FM stations.....23  
Presetting FM stations.....23

## Listening to DAB stations (ISX-18D).....24

Preparing for DAB reception.....24  
Tuning in DAB stations.....24  
Presetting DAB stations.....25

## Using the alarm function.....26

3 types of alarms.....26  
Source.....26  
Snooze.....26  
Setting the alarm time.....27  
Turning the alarm on/off.....27  
Stopping the alarm for a short time(snooze).....28  
Turning the alarm off.....28

## Using the sleep timer.....29

## Updating the firmware.....30

Updating with a "MusicCast CONTROLLER".....30  
Updating with the unit.....30

## Other functions.....31

Disabling the Wi-Fi function.....31  
Disabling the **Bluetooth** function.....31  
Initializing network settings.....32  
Setting the auto standby function.....32

## Troubleshooting.....33

General.....33  
Network.....34  
**Bluetooth**.....36  
FM reception.....37  
DAB reception (ISX-18D).....38

## Supported devices/media and file formats.....39

## Specifications.....40

## Trademarks.....42

# Introduction

Confirm the package contents and useful points of this manual.

## Supplied accessories

□ FM antenna  
(ISX-18)



□ DAB/FM antenna  
(ISX-18D)



□ AC adaptor

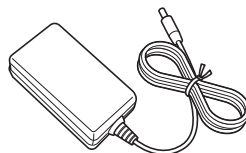

□ Stand



□ Screw



Keep the screw out of reach of children to prevent them from accidentally swallowing a screw.

□ Non-skid pads



□ Quick Manual

□ Safety Brochure

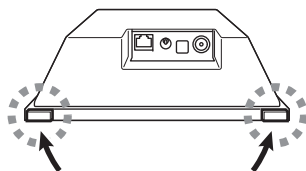

**When placing the unit on a flat surface**, affix the included Non-skid pads to the corners of the unit undersides, as shown. The pads will prevent the unit from moving around.

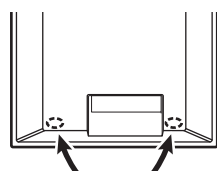

**When hanging the unit on the wall**, to prevent the vibration from the sound from reaching the wall, attach the Non-skid pads on the two corners of the rear panel.

## About this manual

- iOS and Android mobile devices are collectively referred as “mobile devices.” The specific type of mobile device is noted in explanations as needed.
- “iPhone” described in this manual may also refer to “iPod” or “iPad.”
- Illustrations may differ from actual item depicted.
- Symbols:



Indicates precautions for use of the unit and its feature limitations.



Indicates supplementary explanations for better use.



Indicates the corresponding reference page(s).

AC adaptor: DC 12 V, 2.5 A	
Country	Number
U.S.A.	AY30AA-BF1202502-US/-01
Taiwan	AY30AA-BF1202502-TW/-01
Europe, Asia	AY30AA-BF1202502-EU/-01
U.K.	AY30AA-BF1202502-UK/-01
Australia	AY30AA-BF1202502-AU/-01

# Home audio network with MusicCast

## Easy control with the app



MusicCast is a brand new wireless musical solution from Yamaha, allowing you to share music among all of your rooms with a variety of devices. You can enjoy music from your smartphone, PC, NAS drive and music streaming service anywhere in your house with one easy-to-use app. For more details and a lineup of MusicCast compatible products, visit our website.

<http://www.yamaha.com/musiccast/>

System requirements

- For details, search App Store or Google Play™ for “MusicCast CONTROLLER.”
- The application supports iPhone and Android mobile devices.



**To use the unit, you need the dedicated app “MusicCast CONTROLLER” for the operation.  
Install the MusicCast CONTROLLER app to the mobile device.**



## What you can do with this unit

These unit operations are performed with the "MusicCast CONTROLLER" app.  indicates operations that can also be performed from the unit.

### Basic operations

Turn on/standby	
Adjust volume	
Mute	
Switch source	
Adjust sound tone	
Equalizer (Low/Mid/High)	

### Using the clock/alarm

Clock	
Set time (manual/automatic)	
Switch display (12-hour/24-hour)	
Alarm function	
Turn on/off alarm function	
Stop alarm	
Set alarm time	
Set alarm sound	
Adjust alarm volume	
Use snooze	

### Enjoying network content

Listen to music from a mobile device	
Listen to Internet radio	
Play back music files from a PC or NAS	
Play back music with AirPlay	
Listen to network streaming services	
Register contents to "Favorites (PRESET)"	
Register/delete contents	
Recall registered contents	

### MusicCast network

Distribute audio via MusicCast network	
Link distribution	
Adjust audio output	
<i>Bluetooth</i> distribution	

### Bluetooth

Enjoy music with a <i>Bluetooth</i> connection	
Connect to <i>Bluetooth</i> -compatible devices	
Disconnect from <i>Bluetooth</i> -compatible devices	

### Listening to FM/DAB\* radio

Select radio stations (manual/automatic)	
Register stations to "Favorites (PRESET)"	
Manually register/delete radio stations	
Automatically register FM radio stations	
Recall registered radio stations	
Compatible with Initial Scan/Tune Aid for DAB	

\* DAB is compatible only with ISX-18D.

### Specifying unit settings

Set a sleep timer	
Adjust the front panel display brightness (DIMMER)	

### Music enhancer

This function enhances the sound of compressed digital sound by regenerating musical elements that are lost through compression via *Bluetooth* connection.

# Part name

## Top panel

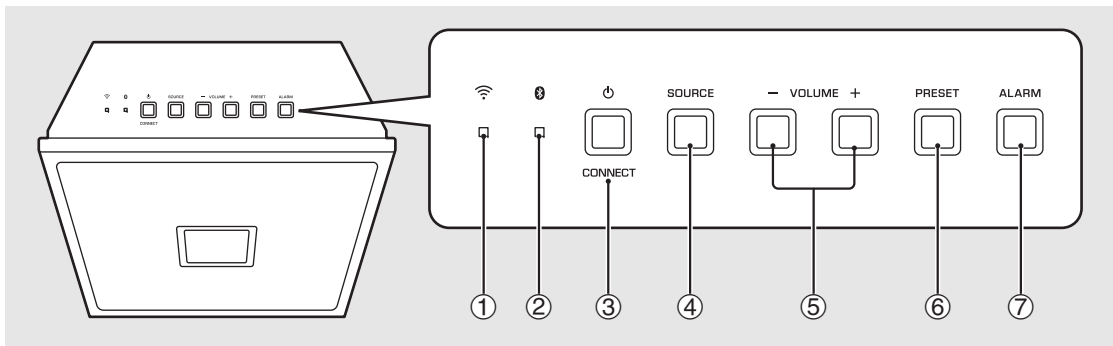

- ① **Wi-Fi indicator** (↪ P.12)
- ② **Bluetooth indicator** (↪ P.20)
- ③ **Power/CONNECT** (↪ P.11)  
Turns the unit on or switches it to standby.
- ④ **SOURCE**  
Switches the playback source.
- ⑤ **VOLUME-/+**  
Controls the volume.
- ⑥ **PRESET** (↪ P.18, 23)  
Recalls registered network contents or radio stations.
- ⑦ **ALARM** (↪ P.27)  
Turns on/off the alarm function and stops the alarm.

## Rear panel

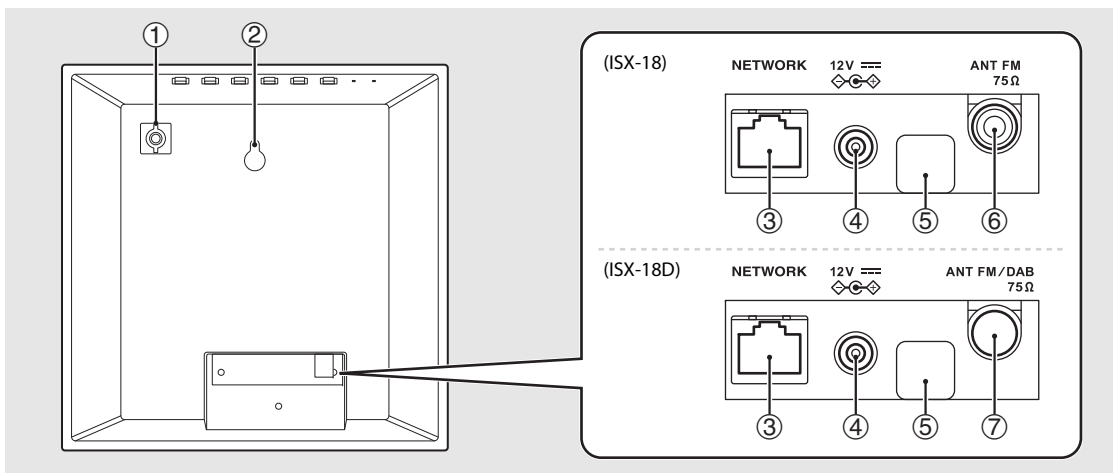

- ① **Screw hole for installing the stand** (↪ P.8)
- ② **Hole for wall-hanging installation** (↪ P.8)
- ③ **NETWORK jack**
- ④ **DC input connector** (↪ P.10)
- ⑤ **Service terminal**  
Terminal for service maintenance: Do not connect cables, and do not remove the attached cap.
- ⑥ **ANT FM jack (ISX-18)** (↪ P.9)
- ⑦ **ANT FM/DAB jack (ISX-18D)** (↪ P.9)

## Front panel display

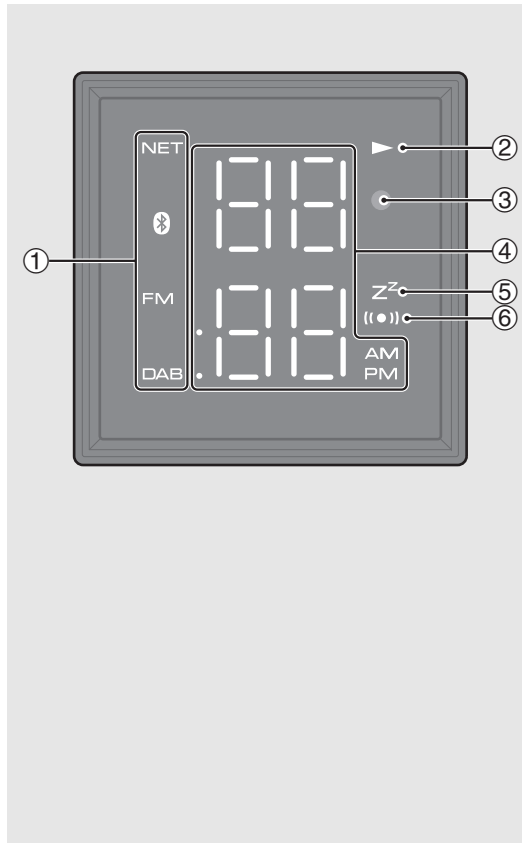

### ① Source indicator

Shows selected source.

NET: Network sources

📶: *Bluetooth*

FM: FM radio

DAB: DAB radio (ISX-18D)

### ② Play indicator

Displays the playback mode.

### ③ Illumination sensor

Detects ambient lighting. Do not cover this sensor.

### ④ Multi-function indicator

Displays various information, including the clock time or volume settings.

### ⑤ Sleep timer indicator

Lights up when the sleep timer is set (☞ P.29).

### ⑥ Alarm indicator

Lights up if the alarm is turned on (☞ P.27).



### Setting the clock of front panel display

You can set the clock time in the “MusicCast CONTROLLER” app. Tap ⚙️ (Settings) in the room select display.

The clock can be automatically synchronized with the clock on your smartphone by using the app (auto setting).

The clock can be set by using the app (manual setting).

- The clock can be switched between a 12-hour and 24-hour display.
- The clock setting will be lost if you disconnect the power cable from the wall outlet for about a week. Set the clock again.

### Adjusting brightness of front panel display

You can set the brightness of front panel display in the “MusicCast CONTROLLER” app. Tap ⚙️ (Settings) in the room select display.

- Auto (default setting): adjusts the brightness automatically to match the surroundings.
- 0: darker
- 1: between 0 and 2
- 2: brighter

When Auto is set, the brightness of the front panel display is adjusted automatically with the illumination sensor. Ensure that the sensor is not covered.

# Preparations

## Installation

### When installing on a shelf

Have a Phillips (+) screwdriver ready to use during assembly.

Attach the stand using the specified screw.

#### Note

- Attach the stand using the specified screw supplied in the package.
- Tighten the screw firmly so that the unit never gets shaky.
- The unit cannot be used by itself. Be sure to complete the installation.
- After installation, place the unit on a stable surface, and observe the following precautions.
  - Do not place on a metal sheet such as sheet iron.
  - Do not cover the unit with cloth.

### When hanging the unit on the wall

#### 1 Insert a screw into the wall.

- Prepare a commercially available tapping screw (screw diameter 3.5 mm to 4 mm (1/8 in)).

#### 2 Hook the hole for wall-hanging installation onto the screw head.

#### Note

- Secure installation is the owner's responsibility. Yamaha shall not be liable for any accident caused by improper installation. If you are uncertain about the wall strength, please consult an installation specialist.

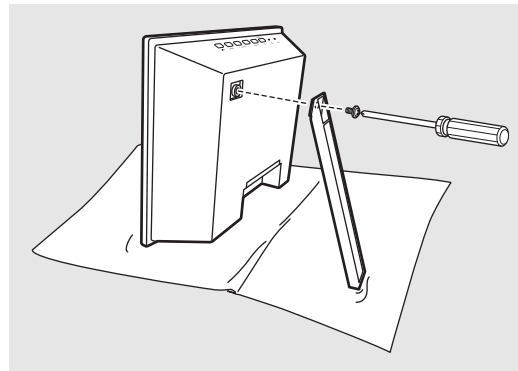

- Spread a soft cloth or other protective mat over the table before installation.
- Keep the screw out of reach of children to prevent them from accidentally swallowing a screw.

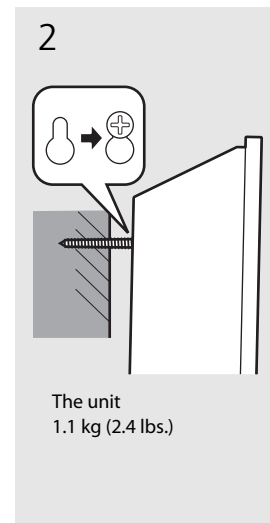
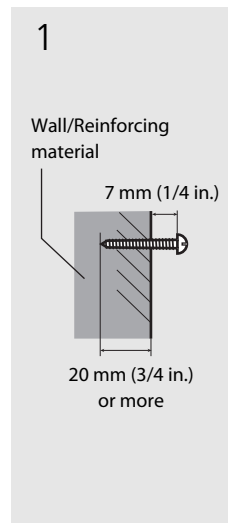

- Make sure that the screw is securely caught by the narrow part of the hole.
- Do not mount the unit on thin plywood or on a wall made of soft material. Otherwise, the screw may pull out of the surface and the unit may fall, possibly damaging it or causing personal injury.
- Do not mount the unit on a wall using nails, adhesives, or unstable hardware. Long term use and vibration may cause the unit to fall.
- To prevent the unit from falling down, it is recommended to attach a commercially available safety wire. Use the supplied screw to attach the safety wire to the screw hole for installing the stand.

## Connecting the FM antenna (ISX-18) or DAB/FM antenna (ISX-18D)

- 1 Connect the supplied antenna to the unit.

(For ISX-18)

Remove the protection cap of the jack.



- Keep the protection cap out of reach of children so as to ensure that it is not mistakenly swallowed.

- 2 Install antenna with pins where the unit can obtain good reception.

- The antenna should be stretched out.
- If radio reception is poor, change the height, direction, or placement of the antenna.
- A commercially available outdoor antenna may improve reception.

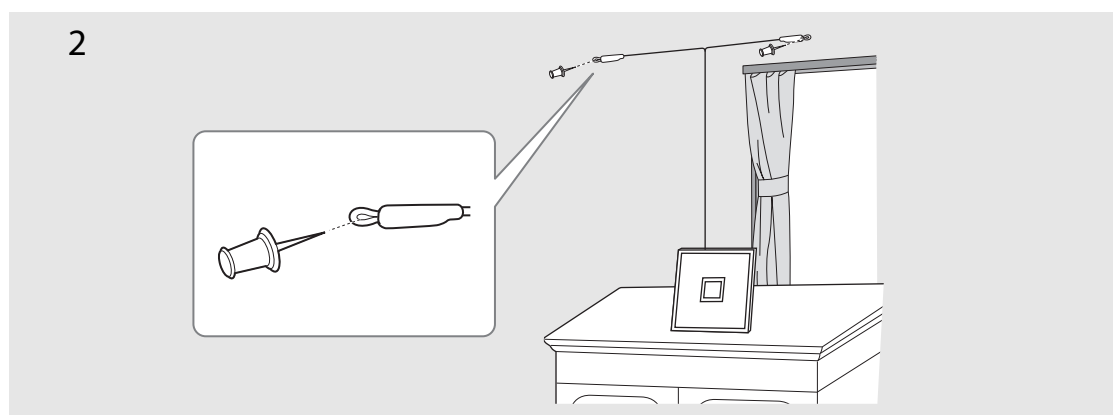
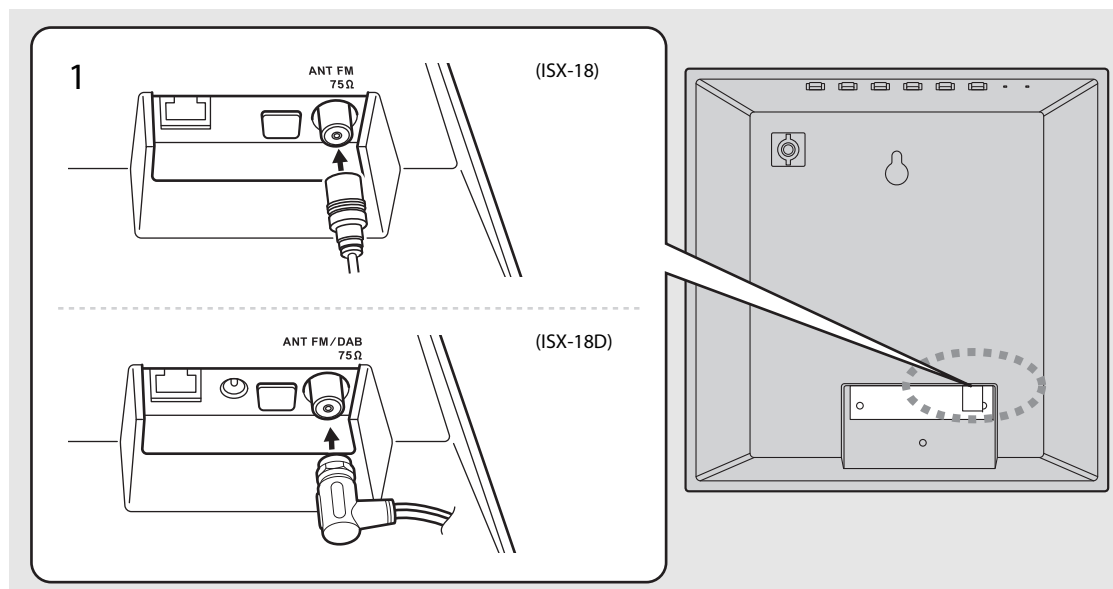

## Connecting AC adaptor

Do not connect the power cable of the unit until you have finished connecting all cables.

- Place the cable so that a hand or foot is not caught by it.

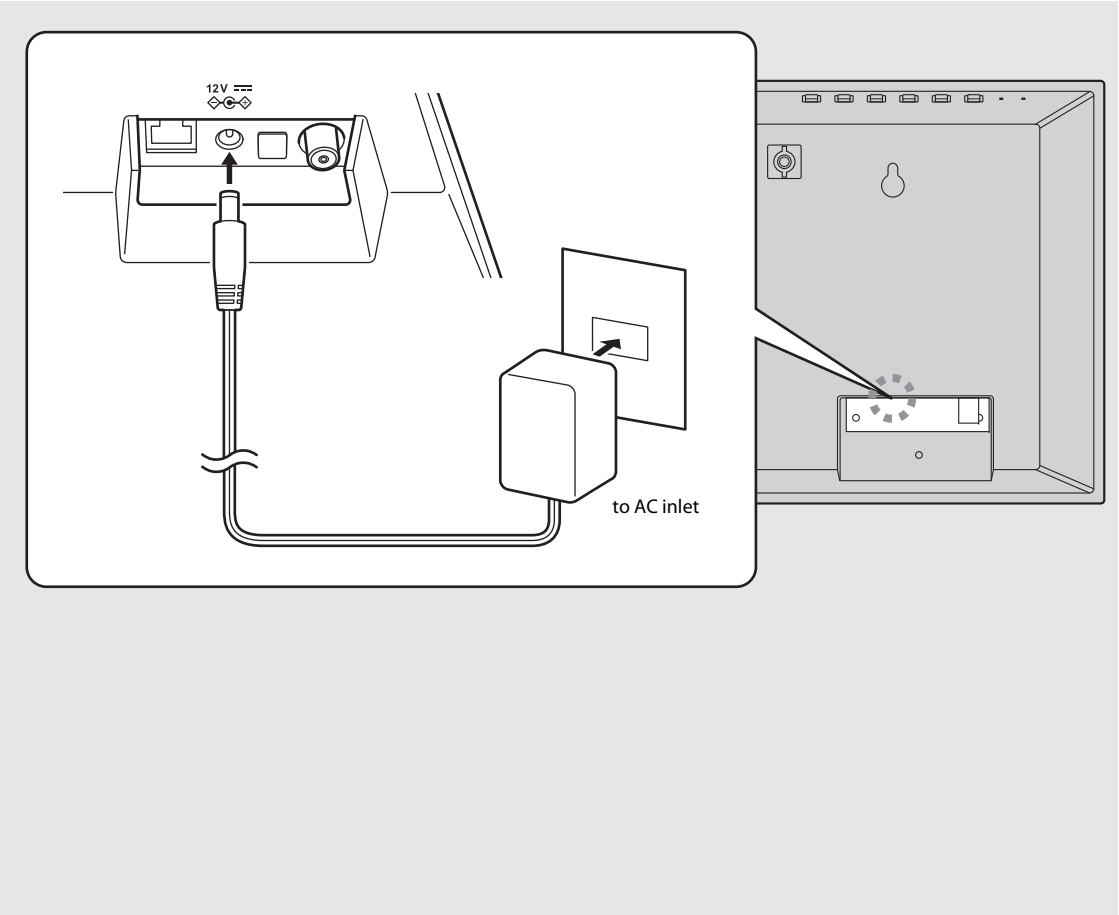

## Turning on the power

Plug the power cable into the wall outlet and press **⏻ (power)/CONNECT**.

- The unit turns on.
- Press **⏻ (power)/CONNECT** again to turn off (standby mode).

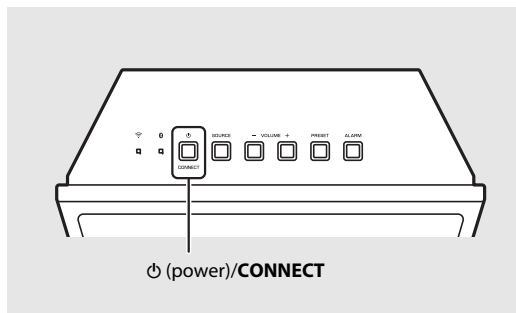

- When you turn on the unit for the first time after purchase, the Wi-Fi indicator blinks and the unit automatically starts to search iOS device (☞ P.14).



- When the unit is turned on, a Source indicator (☞ P.7) lights up.

### Network standby

The unit can be set to display the clock or the network connection status when it is in standby (network standby).

If network standby is turned off, the unit can reduce power consumption without displaying the clock (eco standby). For details, see the table on the right.

Network standby can be turned on /off in the following procedure.

**1** While pressing **ALARM** of the unit, plug the power cable into an outlet.

**2** Press and hold **ALARM**.

- The front panel display shows "ON" or "OFF."

### Status in network standby/eco standby

	Network standby	Eco standby
Enable/disable the alarm	Yes	No
Control from the app	Yes	No
Clock display	Yes	No
Network connection	Yes	No
<b>Bluetooth</b> connection	Yes	No



- When the auto standby is on (default setting), the unit will automatically go into the standby state under the following conditions.
  - When the unit produces no sound of audio input and is not operated for about 20 minutes at selecting **Bluetooth** or NET as the source.
  - When the unit has passed for 8 hours in the FM/DAB reception.

## Connecting to the network

You can play back music files stored on your PC, mobile devices, DLNA\*-compatible NAS, or audio contents on the Internet, by connecting this unit to the network. You can also operate the unit with your mobile device.

\* Digital Living Network Alliance

### Connecting to the network using MusicCast CONTROLLER

#### 1 Start the app, and then tap "Setup."

- If you have already connected a MusicCast compatible device to the network, tap  (Settings) in room select display, and then add this unit as a new device.

#### 2 Turn on the unit.

#### 3 Press and hold the (power)/ **CONNECT** on the unit for 5 seconds.

- Follow the guidance displayed in the app to set.

#### 4 Follow the instructions in the MusicCast CONTROLLER app to play music.

- When the unit is connected to a network via a wireless connection, the Wi-Fi indicator ( P.6) lights up.

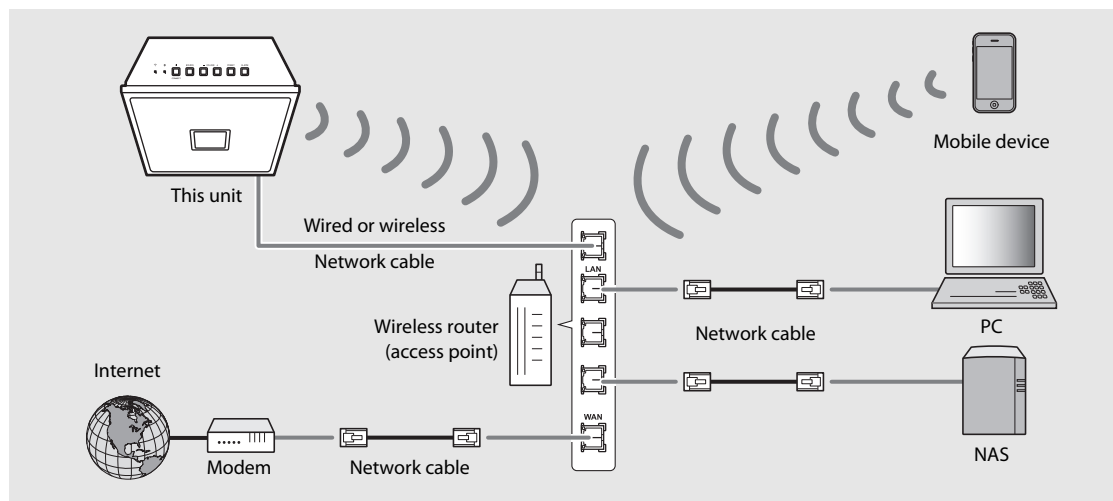

- For details on Internet connection, refer to the owner's manuals of your network devices.
- Some security software installed on your PC or the firewall settings of network devices (such as a router) may block the access of the unit to the network devices or the Internet. In this case, change the setting of the security software or network devices.
- If you connect the unit to the network with a network cable, connect with a commercially available STP (shielded twisted pair) network cable (straight, CAT-5 or higher).
- For network connection, "MusicCast CONTROLLER" is required. Before making connection, connect the mobile device where "MusicCast CONTROLLER" has been installed to the wireless router (access point) you will use.



## Setting of the devices and playback

Create the following network (MusicCast Network) using the MusicCast CONTROLLER app.



- If you want to install a MusicCast compatible device to a location that is out of range of the wireless router, connect another MusicCast support device to the router with a network cable to extend the range (Extend mode).

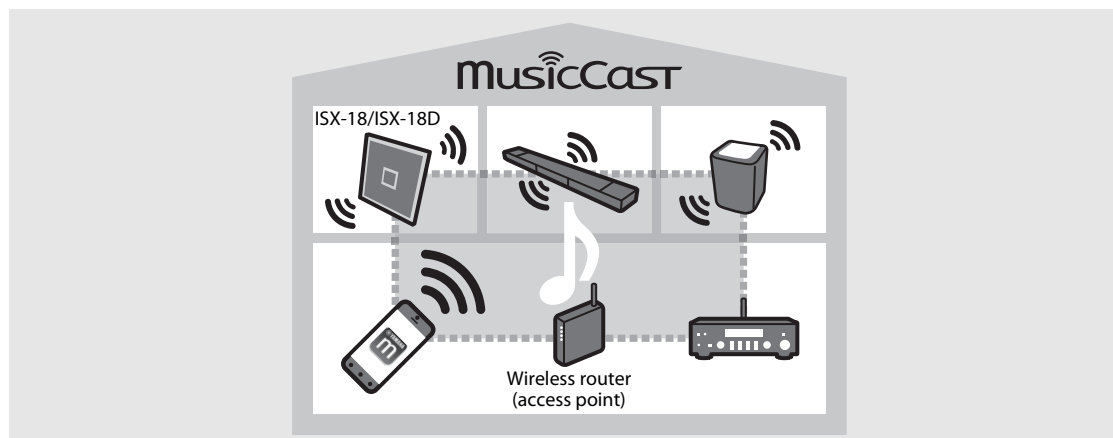

- Depending on where it is placed, the MusicCast compatible device may not be able to playback a high-resolution audio source. In this case, connect the device directly to the router with a network cable.

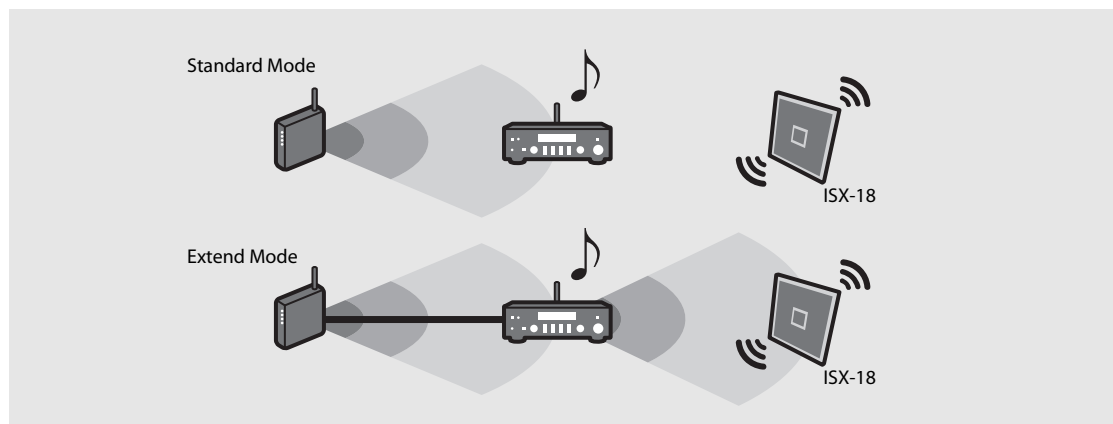

## Connecting to the network by sharing the iOS device setting

When you turn on the unit for the first time after purchase or initialization of network settings (☞ P.12), the Wi-Fi indicator blinks and the unit automatically starts to search iOS device (such as iPhone). You can easily setup a wireless connection by applying the network settings on iOS devices.

Before proceeding, confirm that your iOS device is connected to a wireless router (access point).

This setting does not need to be specified if the unit is connected to a network with "MusicCast CONTROLLER."

### Display the Wi-Fi setup screen on the iOS device and select the unit from "SETUP A NEW AIRPLAY SPEAKER...."

- Follow the on-screen instructions displayed on the iOS device.
- In order to enjoy all features of the unit, connect it to a network with "MusicCast CONTROLLER" (☞ P.12).



- You need iOS device with iOS 7.1 or later.
- The network settings on iOS devices cannot be applied to the unit to establish a wireless connection if your wireless router (access point) uses WEP encryption.

# Playing network contents

This unit allows you to play back music files such as MP3, WMA, or FLAC (lossless audio data compression format) files stored in the computer (server) connected to the network or NAS. You can also listen to world-wide radio stations via the Internet.

## Listening to the songs in the computer

### Setting the media sharing of music files

To play back music files in your computer with this unit, you need to make the media sharing setting between the unit and computer (Windows Media Player 11 or later). In here, setting with Windows Media Player 12 in Windows 7 is taken as an example.

- 1 Start Windows Media Player 12 on your PC.
- 2 Select "Stream," then "Turn on media streaming."
  - The control panel window of your PC is shown.
- 3 Click "Turn on media streaming."
- 4 Select "Allowed" from the drop-down list next to the unit's model name.
- 5 Click "OK" to exit.

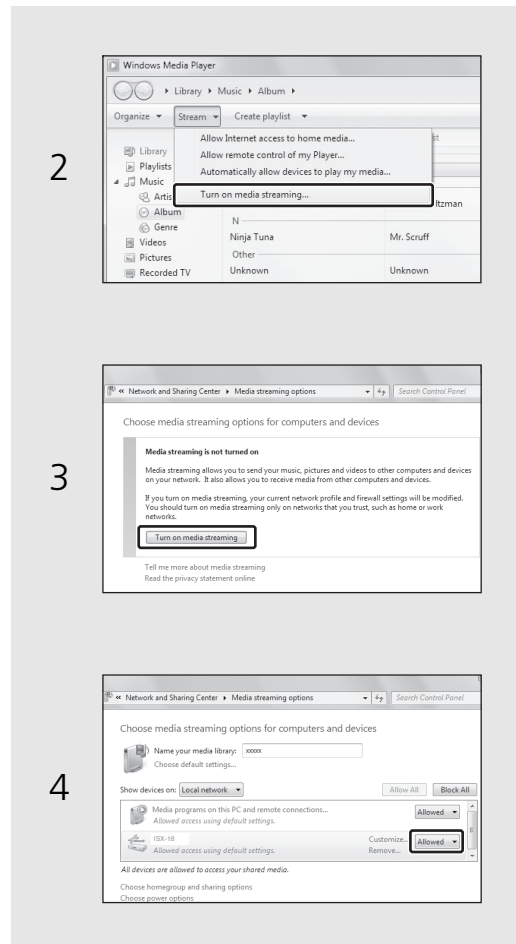

- For details on media sharing settings, refer to Windows Media Player help.

### For Windows Media Player 11

- 1 Start the Windows Media Player 11 on your PC.
- 2 Select "Library" then "Media Sharing."
- 3 Check the "Share my media to" box, select the "ISX-18" icon, and click "Allow."
  - The names on the list are device names (Room names). You can set Room names on  (Settings) in the room select display. If the Room name is not set, the Room name is "ISX-18 \*\*\*." (\*\*\*) is an arbitrary number.)
- 4 Click "OK" to exit.

Refer to the owner's manual of your device or software and configure the media sharing settings.

### For a PC or a NAS with other DLNA server software installed

Refer to the owner's manual of your device or software and configure the media sharing settings.

- The names on the list are device names (Room names). You can set Room names on  (Settings) in the room select display. If the Room name is not set, the Room name is "ISX-18 \*\*\*." (\*\*\*) is an arbitrary number.)

## Playing back songs in the PC

- 1 In the "MusicCast CONTROLLER," select "Server."
- 2 Play back songs by following the indication of "MusicCast CONTROLLER."



- You can store your favorite songs beforehand (P.18).

## Listening to Internet radio

You can listen to Internet radio stations from all over the world.  
Make sure that the unit is connected to the Internet properly (☞ P.12).

- 1 In the "MusicCast CONTROLLER," select "Net Radio."
- 2 Play the radio by following the indication of "MusicCast CONTROLLER."

## Supports streaming services

You can enjoy music from a variety streaming services.  
Make sure that the unit is connected to the Internet properly (☞ P.12).

- Service is limited to certain areas.
- This service may not be available for units purchased in some regions.
- Service may change or be discontinued without notice.



- You can store your favorite stations beforehand (☞ P.18).
- You can use the advanced feature of vTuner (such as adding a new station to the list) by accessing the following website with the web browser on your PC.  
<http://radio.vtuner.com/>
  - Before registering the Internet radio station, play any Internet radio station with this unit.
  - To create a necessary account for registration, you need the vTuner ID of this unit and your e-mail address. You can check the vTuner ID on  (Settings) in the room select display.

## ▮ Presetting network contents

Up to 40 contents can be registered. You can easily play back contents after registered.

### Using “MusicCast CONTROLLER”

#### Presetting contents

- 1 Use “MusicCast CONTROLLER” to play back the content you want to register.
- 2 Register the contents by following the indication of “MusicCast CONTROLLER.”

#### Selecting preset contents

- 1 Select a registered content from “Favorites” of “MusicCast CONTROLLER.”

### Using the buttons on the unit

#### Selecting preset contents

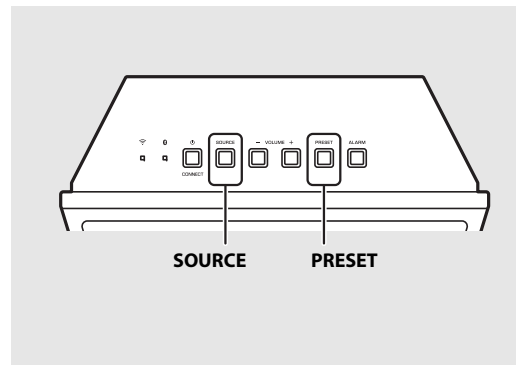

- 1 Press **SOURCE** to select the network source.
- 2 Press **PRESET** to select the content.





# Listening to the Music with AirPlay

The AirPlay function allows you to play back iPhone/iTunes music on the unit wirelessly via a network. Make sure that the unit and your PC or iPhone are connected to the same router (☞ P.12).

## ▶ Playing back songs with iPhone

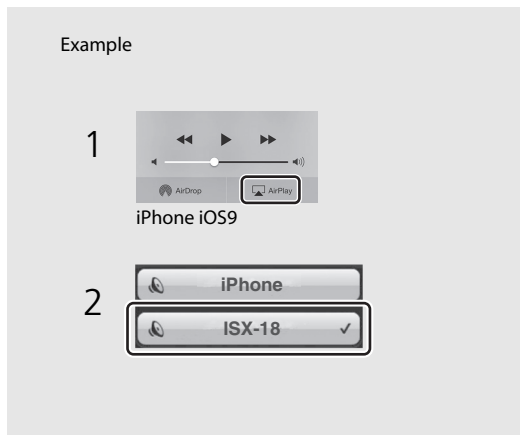
- 1 Turn on the unit and display the playback screen on the iPhone.
  - If the iPhone recognizes the unit,  is shown on the screen of the iPhone.
- 2 Tap  and select the unit's name.
  - The source automatically switches to "AirPlay" (except in the eco standby mode).
- 3 Select a song and start playback.





- For an iPhone with iOS7/iOS8/iOS9 installed,  is displayed within the control center. To display the control center, swipe the iPhone screen in an upward direction.



### Clearing AirPlay

- Tap/click  on the iPhone/iTunes screen and select a device other than the unit from the speaker list. Or, change the source to other than AirPlay.

## ▶ Playing back songs with iTunes

- 1 Turn on the unit and start iTunes.
  - If the iTunes recognizes the unit,  is shown on the screen of iTunes.
- 2 Click  and select the unit's name.
  - The source automatically switches to "AirPlay" (except in the eco standby mode).
- 3 Play back songs with iTunes.

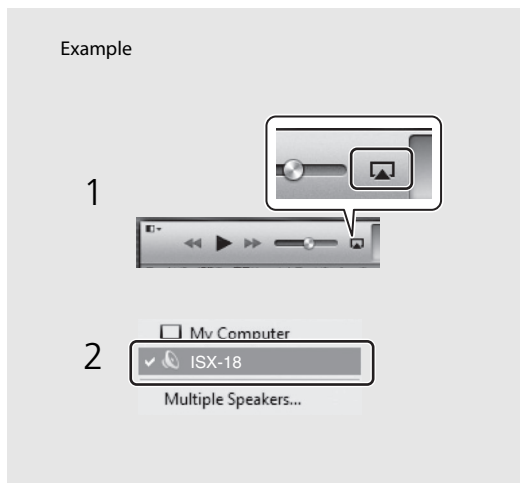

# Listening to music via *Bluetooth* connection

You can listen to sound wirelessly from a *Bluetooth* compatible device.

## Pairing a *Bluetooth* device with the unit

- 1 Press **SOURCE** to set the source to *Bluetooth*.
- 2 Turn on the *Bluetooth* function on your device.
- 3 In the *Bluetooth* setting of the device, select the unit (network name of the unit).
  - After pairing is complete, the *Bluetooth* indicator (☞ P.6) lights up when a *Bluetooth* connection is established.
  - If the device does not connect to the unit automatically after the pairing is completed, select the unit (network name of the unit) again in the *Bluetooth* setting on your device.
  - For details, see the owner's manual of your device.
- 4 Play back music on your device.

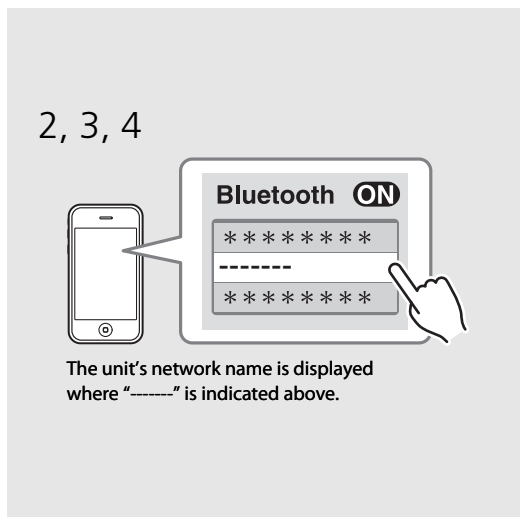
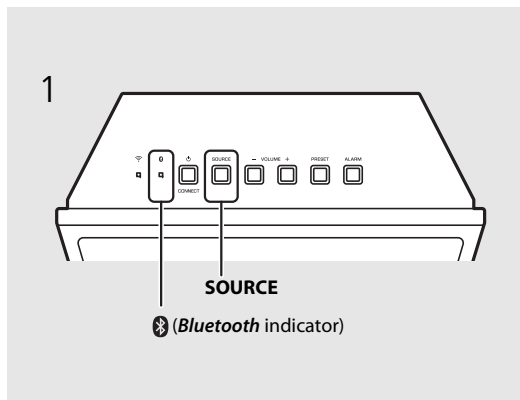

When connecting a *Bluetooth* device to the unit for the first time, the device is required to be registered to the unit. This process is called "pairing."

Once pairing is completed, subsequent connection can be made with a couple of easy steps.

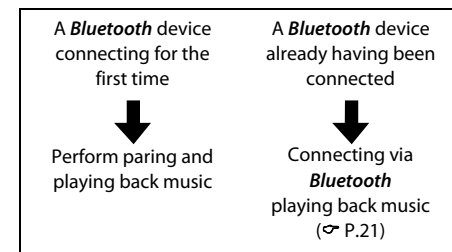

- If another device is already connected to the unit, press and hold **SOURCE** to terminate the *Bluetooth* connection, then perform pairing with the new device.
- If pairing information for a device is deleted, you will need to perform pairing of that device again in order to connect it again.
- You can check or change the network name of this unit with "MusicCast CONTROLLER."
- If a passkey is required during the pairing operation, enter the number "0000."



## Connecting a paired **Bluetooth** device and playing back music

If the unit is connected to another device via **Bluetooth** connection, terminate that connection (see “Terminating the **Bluetooth** connection” on the right) before connecting to the target device.

### 1 Perform **Bluetooth** connection.

- **Connecting from the unit:**

Press **SOURCE** to set the source to **Bluetooth** input source.

- **Connecting from the **Bluetooth** device:**

Turn on the **Bluetooth** function of the connected device, and select the unit (network name of the unit) from the available device list.

- The **Bluetooth** indicator (☞ P.6) lights up when a connection is established.

### 2 Play back music on the connected device.



- **Decrease the volume of the unit before playback.** Otherwise, playback volume may be too loud.



- If connecting from the unit, the unit searches for the **Bluetooth** device connected the last time. In this case, make sure that device's **Bluetooth** function is turned on.

#### Terminating the **Bluetooth** connection

**Bluetooth** connection can be terminated by either one of the following.

- Press **SOURCE** to set the another input source.
- Set the unit to standby mode.
- Terminate the **Bluetooth** connection from the connected device.
- When **Bluetooth** is selected as the input source, terminate the connection by pressing and holding **SOURCE**.

## Listening to music through wireless headphones

You can listen to the audio played back by this unit through **Bluetooth**-compatible wireless headphones. The audio will be transmitted to the wireless headphones using "MusicCast CONTROLLER" installed on your mobile device.

1 Set the **Bluetooth** connection for the **Bluetooth** device (wireless headphones, etc.) to standby.

2 Tap  in the playback display of "MusicCast CONTROLLER."

3 Tap "Bluetooth Transmission."

4 Select the **Bluetooth** device (wireless headphones, etc.).

- When the connection is established, the **Bluetooth** indicator ( P.6) lights up.

5 Tap "Done."

- The sound is output by the receiving **Bluetooth** device (wireless headphones, etc.).

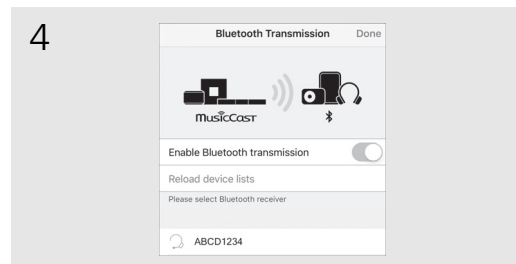
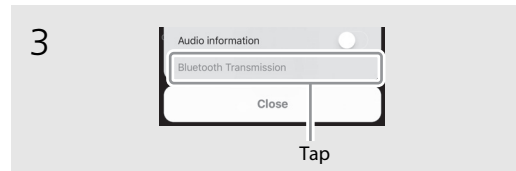
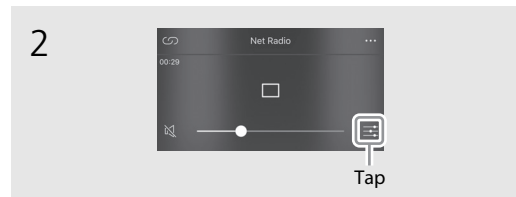
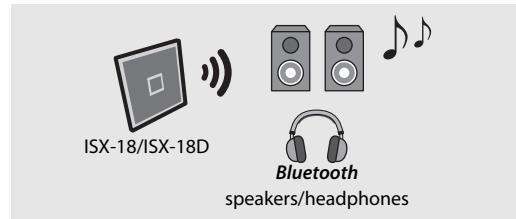

- ! Use **Bluetooth** devices compatible with the A2DP profile.
- Audio from AirPlay or a **Bluetooth** device cannot be transmitted to and output by another **Bluetooth** device.

- 💡 The playback sound is also output by the unit.
- The "MusicCast CONTROLLER" app displays shown here are from an iPhone.
- For details on using your **Bluetooth** device, refer to its owner's manual.

# Listening to FM radio stations

To listen to FM radio stations, connect the supplied FM antenna.

See "Connecting the FM antenna (ISX-18) or DAB/FM antenna (ISX-18D)" (P.9) for connecting the antenna to the unit.

## Tuning in FM stations

- 1 In the "MusicCast CONTROLLER," select "Tuner."
- 2 Select FM station by following the indication of "MusicCast CONTROLLER."

## Presetting FM stations

Up to 30 contents can be registered.

### Using "MusicCast CONTROLLER"

#### Presetting stations

- 1 Tune into a station you want to register.
- 2 Register the station by following the indication of "MusicCast CONTROLLER."

#### Selecting preset stations

- 1 Select a registered radio station from "Favorites" of "MusicCast CONTROLLER."

### Using the buttons on the unit

#### Selecting preset stations

- 1 Press **SOURCE** to select "FM."
- 2 Press **PRESET** to select the radio station.

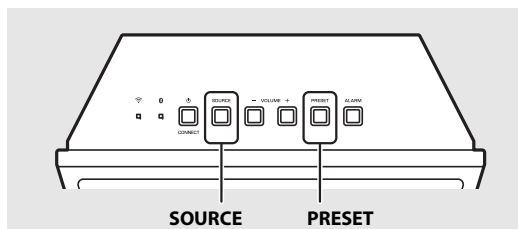

- From the menu on the playback screen, you can also automatically register to receive all possible FM stations (auto preset function).

# Listening to DAB stations (ISX-18D)

DAB (Digital Audio Broadcasting) and DAB+ use digital signals for clearer sound and more stable reception compared to analog signals. DAB+ is based on the original DAB standard but uses a more efficient audio codec.

DAB and DAB+ are broadcast in blocks of data called “ensembles” containing up to several radio stations that are simultaneously broadcast.

DAB and DAB+ can also include an extensive amount of text information, enabling you to select a station by name.

Other information, such as the ensemble name or the status of the digital signal, can be displayed on the DAB information display.

“DAB” described in this manual may also refer to “DAB+.”

## ► Preparing for DAB reception

Before tuning into DAB stations, an initial scan must be performed.

- 1 In the “MusicCast CONTROLLER,” select “**Tuner.**”
- 2 Select “**DAB**” by following the indication of “MusicCast CONTROLLER.”
- 3 Tap **:** in the playback display of “MusicCast CONTROLLER.”
- 4 Tap “Initial Scan” and then “Yes” to start the initial scan.

## ► Tuning in DAB stations

- 1 In the “MusicCast CONTROLLER,” select “**Tuner.**”
- 2 Select DAB station by following the indication of “MusicCast CONTROLLER.”

## Presetting DAB stations

Up to 30 contents can be registered.

### Using "MusicCast CONTROLLER"

#### Presetting stations

- 1 Tune into a station you want to register.
- 2 Register the station by following the indication of "MusicCast CONTROLLER."

#### Selecting preset stations

- 1 Select a registered radio station from "Favorites" of "MusicCast CONTROLLER."

### Using the buttons on the unit

#### Selecting preset stations

- 1 Press **SOURCE** to select "DAB."
- 2 Press **PRESET** to select the radio station.

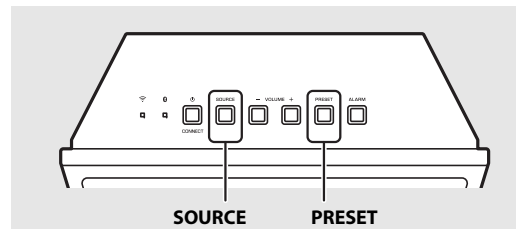

- The Tune Aid function can also be used to check the signal quality.

# Using the alarm function

The unit includes an alarm function (IntelliAlarm) that plays back music sources or beeps (built-in alarm) at the set time in a variety of different methods. Before using the alarm function, set the time in the clock (☞ P.7). The alarm function has following features.

## 3 types of alarms

Use “MusicCast CONTROLLER” to make setting. Select from 3 alarm types, combining music and beep sounds. Follow the indication of “MusicCast CONTROLLER” to make setting.

Source only	The selected audio source is played at the set time. The volume fades in gradually and increases to the set volume.
Source with beep	The selected audio source and beep sound are played at the set time. This mode is recommended for the best possible start to the day. 3 minutes before the set time: the source music begins to fade in and the volume gradually increases as the alarm time approaches. Alarm time: a beeping sound also begins playing.
None	If the beep has been turned on (☞ P.27), only the beep sound will be played.

## Source

Network contents and radio can be selected. The following can also be selected depending on the audio source.

Source	Playback method	Function
Network contents	Preset	Plays back the specified network content.
	Resume	Plays back the last network content played back.
FM radio	Preset	Plays the selected preset radio station.
	Resume	The radio station you listened to last time is played back.
DAB (ISX-18D)	Preset	Plays the selected preset DAB station.
	Resume	The DAB station you listened to last time is played back.



- Devices connected via **Bluetooth** cannot be used as music source.

## Snooze

The alarm sound stops and resumes after 5 minutes (☞ P.28).

## Setting the alarm time

- 1 Tap  (Settings) in the room select display of "MusicCast CONTROLLER."
- 2 Follow the instructions in "MusicCast CONTROLLER" to specify settings for the following.
  - Alarm time
  - Repeat function enabled/disabled
  - Beep on/off
  - Alarm volume
- 3 Select the playback source.
  - Depending on the circumstances of the source selected at the alarm time, sound may not be output.



- The  indicator and alarm time setting flashes on the front panel display when the alarm time setting is being changed. When finished, it remains illuminated.

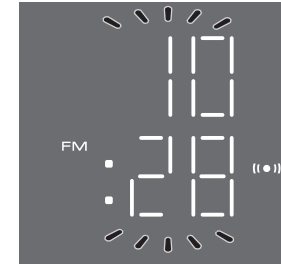

## Turning the alarm on/off

Press **ALARM**.

- When the alarm is turned on,  lights up, and the alarm time is shown for a while. When  is turned off by pressing **ALARM** again, the alarm is turned off.

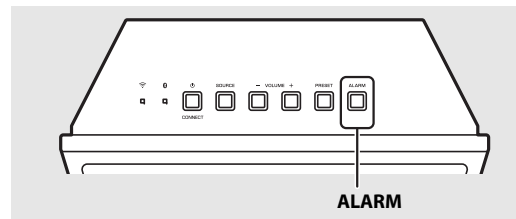

- The alarm setting will be saved even if the alarm is turned off. If the alarm is turned on again by pressing **ALARM**, the alarm will sound with the previous alarm settings.

## Stopping the alarm for a short time (snooze)

Press **SOURCE** or **PRESET** during the alarm playback.

- Stop the alarm and resume again in 5 minutes.

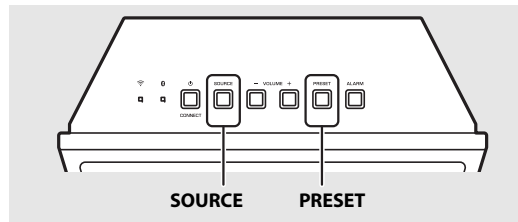

- When source and beep is set, press **SOURCE** or **PRESET** once to stop the beep sound, and twice to stop the audio source. 4 minutes after the audio source is stopped, it will start fading in again and after another minute the beep sound will resume.
- The (●) indicator flashes on the front panel display while the snooze mode is activated.

## Turning the alarm off

Press **ALARM** or **(power)/CONNECT** during the alarm playback.

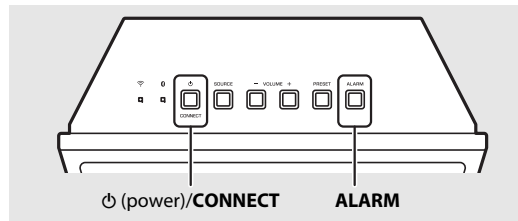



- The alarm stops automatically after 60 minutes unless you stop the alarm.
- The alarm setting will be saved even if the alarm is turned off. If the alarm is turned on again by pressing **ALARM**, the alarm will sound with the previous alarm settings.



# Using the sleep timer

You can set the time to elapse which the unit automatically enters to standby mode.

- 1 Tap  in the playback display of "MusicCast CONTROLLER."
- 2 Follow the instructions in "MusicCast CONTROLLER" to set the time.

- Time can be selected from 120/90/60/30 min., or Off.
-  lights up after the time is selected, and the sleep timer is set.



- To cancel the sleep timer, set it to "Off" in "MusicCast CONTROLLER."

# Updating the firmware

When new firmware is detected from the network, "UP" will be shown on the front panel display (press any button to turn off the "UP" indication on the front panel display). There are two ways to updating the firmware.

## Updating with a "MusicCast CONTROLLER"

You can use "MusicCast CONTROLLER" to update the firmware. Follow the indication of "MusicCast CONTROLLER" to update the firmware.

## Updating with the unit

- 1 Press **⏻** (power)/**CONNECT** to turn the unit off.
- 2 Pull out the plug from the wall outlet.
- 3 While pressing **PRESET**, plug the power cable into the wall outlet.
  - The "UP" indications flash on the unit.
- 4 Press **PRESET**.
  - The unit starts updating the firmware. When finished, the display flashes as shown in the figure.



- 5 Press **⏻** (power)/**CONNECT** to check that the normal display is returned.

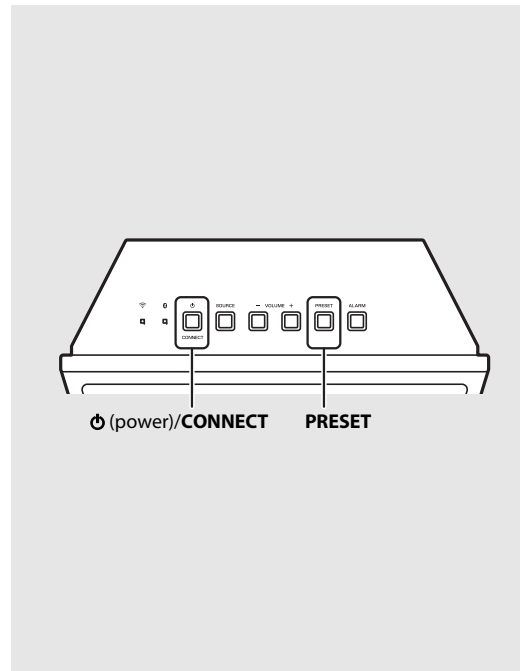



- Do not operate the unit or disconnect the power cable while updating.



- When Internet speed is not fast enough, network update may not be possible depending on the condition of the wireless connection. If the firmware update fails, the "Er" indication flashes. In that case, try updating again after a while.

# Other functions

## Disabling the Wi-Fi function

- 1 Press  (power)/**CONNECT** to turn the unit to standby.
- 2 Press and hold **SOURCE** and **PRESET** at 5 seconds.
  - The NET and  (**Bluetooth**) indicators flash alternately on the front panel display.
- 3 Within 10 seconds, hold down **VOLUME –** for 2 seconds.
  - "OFF" will be shown on the front panel display when you disable the Wi-Fi function.
  - To enable the Wi-Fi function, follow the procedures in "Connecting to the network" (☞ P.12) and reconnect the unit to the network.
  - When the source is switched to network content while the Wi-Fi function is disabled and no network cable is connected, "OFF" will be shown on the front panel display.





- Set the network standby setting (☞ P.11) to "ON."



- The wireless function is enabled, when you connect to the network or the network setting is initialized.

## Disabling the *Bluetooth* function

- 1 Press  (power)/**CONNECT** to turn the unit to standby.
- 2 Press and hold **SOURCE** and **PRESET** at 5 seconds.
  - The NET and  (**Bluetooth**) indicators flash alternately on the front panel display.
- 3 Within 10 seconds, hold down **VOLUME +** for 2 seconds.
  - Each time the operation is repeated, this function switches to enable/disable, and "ON"/"OFF" will be shown on the front panel display.
  - When the source is switched to *Bluetooth* under the *Bluetooth* function disabled, "OFF" will be shown on the front panel display.

## Initializing network settings

- 1 Press **⏻** (power)/**CONNECT** to turn the unit to standby.
- 2 Pull out the plug from the outlet.
- 3 While pressing **⏻** (power)/**CONNECT**, plug the power cable into an outlet.
  - After the Source indicator (NET and **⊗**) flashes for several seconds, the screen changes to the clock display.



## Setting the auto standby function

If about 20 minutes have elapsed with no playback and no operation while the unit is on, it will automatically enter standby. You can change the auto standby function setting in the "MusicCast CONTROLLER" app. Tap  (Settings) in the room select display, and then change the setting.

# Troubleshooting

Refer to the table below when the unit does not function properly. If your problem is not listed below or if the instruction below does not help, turn off the unit, disconnect the power cable, and contact the nearest authorized Yamaha dealer or service center.

**First, check that the connectors of each cable are securely inserted in to jacks on each device.**

## General

Problem	Cause	Solution
The unit enters the standby mode soon after the power is turned on. The unit does not operate properly.	The power cable is not properly connected.	Connect the power cable firmly.
	The unit got a strong electric shock from an outside source, such as lighting or excessive static electricity.	Unplug the power cable from the outlet, and plug it again after about 30 seconds.
No sound.	No appropriate source has been selected.	Select an appropriate source with <b>SOURCE</b> on the unit.
	The volume is minimum or mute.	Turn up the volume.
	The power is off.	Turn on the unit and play the music again.
	Auto Standby function is activated.	
Sound is cracked/distorted or there is abnormal noise.	The volume of the input music source is high. Or the volume of the unit is set to a high level.	Adjust volume with <b>VOLUME</b> .
The power is suddenly turned off.	The sleep timer may be set (☞ P.29).	Turn on the unit and play the source again.
	Auto Standby function is activated (☞ P.32).	
The selected source does not play back at the alarm time.	The alarm source is set to "None".	Follow the indication of "MusicCast CONTROLLER" to set another alarm source.
	The selected content is not currently provided.	There may be a network problem, or the service may have been stopped. Select another content.
	The selected content is playing back silence.	Some content silence at certain of times of the day. In this case, no sound is output even if the content is received. Select another content.
The clock display does not appear in the standby state.	The unit is set to eco standby mode.	Set the standby mode to network standby (☞ P.11).

Problem	Cause	Solution
The front display becomes dim.	The front display setting is set to Auto.	Set the brightness of the front panel display to a setting other than Auto. Or, do not cover the illumination sensor.
The clock setting has been cleared.	The power cable of the unit was unplugged from the outlet. Or an outage occurred.	Connect the power cable, and set the clock again (☞ P.7).
There is noise interference from digital or high-frequency equipment.	This unit is too close to the digital or high-frequency equipment.	Place this unit farther away from such equipment.

## Network

Problem	Cause	Solution
The network feature does not function.	The network parameters (IP address) have not been obtained properly.	Enable the DHCP server function of the router. For details on how to set the router, contact the manufacturer of the router.
Playback stops (songs cannot be played back continuously).	There are unsupported files in the server.	Remove the files (including image files or hidden files) which the unit does not support, from the folder being played back.
The unit does not detect the PC.	The media sharing setting of the PC is not correct.	Configure the sharing setting of the PC and select the unit as a device to which music contents are shared (☞ P.15).
	Some security software installed on your PC is blocking the access of the unit to your PC.	Check the setting of the security software installed in your PC.
	The unit and PC are not in the same network.	Check the network connections and your router settings, and then connect the unit and the PC to the same network.
The files in the PC cannot be viewed or played back.	The files are not supported by the unit or the media server.	Use the file format supported by both the unit and the media server (☞ P.39).

Problem	Cause	Solution
The Internet radio cannot be played.	The selected Internet radio station is currently not available.	There may be a network problem at the radio station, or the service may have been stopped. Try the station later or select another station.
	The selected Internet radio station is currently broadcasting silence.	Some Internet radio stations broadcast silence at certain of times of the day. In this case, no sound is output even if the radio waves are received. Try the station later or select another station.
	Access to the network is restricted by the firewall settings of your network devices (such as the router).	Check the firewall settings of your network devices. The Internet radio can be played only when it passes through the port designated by each radio station. The port number varies depending on the radio station.
The "MusicCast CONTROLLER" app does not detect the unit.	The unit and mobile devices are not in the same network.	Check the network connections and your router settings, and then connect the unit and the PC to the same network.
Update of the firmware failed.	The network connection is unstable.	Try updating again after a while.
The unit cannot connect to the Internet via a wireless router (access point).	The unit and the wireless router (access point) are too far apart.	Place the unit and the wireless router (access point) closer to each other.
	There is an obstacle between the unit and the wireless router (access point).	Place the unit and the wireless router (access point) without any obstacle between them.
Wireless network is not found.	Wireless communication is interrupted by the electromagnetic waves emitted from a microwave oven or other wireless devices.	When using the unit via wireless connection, place it away from devices emitting electromagnetic waves.
	Access to the network is restricted by the firewall settings of your wireless router (access point).	Check the firewall setting of the wireless router (access point).
The iPhone does not recognize the unit when using AirPlay.	A multi-SSID supported router is used.	The network separation function of the router may prevent the iPhone from accessing the unit. When connecting an iPhone, use SSID that can access the unit.

## **Bluetooth**

Problem	Cause	Solution
Cannot make the unit pair with a <i>Bluetooth</i> device.	The unit is turned off.	Turn the unit on and perform the pairing (☞ P.20).
	Another <i>Bluetooth</i> device is connected.	Terminate current <i>Bluetooth</i> connection, and perform pairing with the new device.
	This unit and the device are too far apart.	Pair the unit and device within a distance of 10 m (33 ft).
	There is a device (microwave oven, wireless network, etc.) that outputs signals in the 2.4 GHz frequency band nearby.	Move this unit away from the device that is emitting radio-frequency signals.
	A <i>Bluetooth</i> adapter, etc., that you want to pair with this unit has a passkey other than "0000."	Use a device whose passkey is "0000."
	The <i>Bluetooth</i> device does not support A2DP.	Perform pairing with a device which supports A2DP.
Cannot make a <i>Bluetooth</i> connection.	The unit is turned off.	Turn the unit on.
	Another <i>Bluetooth</i> device is connected.	Terminate current connection, then establish a connection with that device again.
	The <i>Bluetooth</i> function of the device is turned off.	Turn on the <i>Bluetooth</i> function of the device.
	The pairing information has been deleted.	Delete the pairing history for this unit from the <i>Bluetooth</i> device, and then perform pairing again (☞ P.20).
	This unit is not registered on the device's <i>Bluetooth</i> connection list.	Perform pairing again (☞ P.20).



Problem	Cause	Solution
No sound is produced, or the sound is interrupted during playback.	The volume of the connecting device is set too low.	Turn up the volume of the connecting device.
	The connecting device is not set to send <b>Bluetooth</b> audio signals to the unit.	Switch the output of <b>Bluetooth</b> audio signals of the connecting device to the unit.
	The <b>Bluetooth</b> connection of the unit with the device has terminated.	Perform <b>Bluetooth</b> connection operations again (☞ P.21).
	There is a device (microwave oven, wireless network, etc.) that outputs signals in the 2.4 GHz frequency band nearby.	Move this unit away from the device that is emitting radio-frequency signals.
	This unit and the connecting device are too far apart.	Move the connecting device to within 10 m (33 ft) of the unit.
	The <b>Bluetooth</b> function of the device is turned off.	Turn on the <b>Bluetooth</b> function of the device.
	The connecting device is not set to send <b>Bluetooth</b> audio signals to this unit.	Check that the <b>Bluetooth</b> function of the connecting device is set properly.

## FM reception

Problem	Cause	Solution
FM stereo reception is noisy.	The antenna is not connected properly.	Make sure the antenna is connected properly and change the position of the antenna (☞ P.9).
	The radio station you selected may be far from your area, or the antenna input is poor.	Use a commercially available outdoor antenna. For details, consult a specialist store.
Automatic tuning does not work.	The radio station you selected may be far from your area, or the antenna input is poor.	Use a commercially available outdoor antenna. For details, consult a specialist store.
		Use the manual tuning method (☞ P.23).
Cannot select a preset radio station.	The preset (memory) may have been erased.	Preset radio stations again (☞ P.23).
There is distortion, and clear reception cannot be obtained even with a good FM antenna or an outdoor antenna.	Multipath reflection or other radio interference may have occurred.	Change the height, direction, or placement of the antenna.

## DAB reception (ISX-18D)

Problem	Cause	Solution
Cannot tune into any DAB stations.	The initial scan operations were not performed.	Perform the initial scan operations (☞ P.24).
	There is no DAB coverage in your area.	Check with your dealer or WorldDMB Online at "http://www.worlddab.org" for a listing of the DAB coverage in your area.
The initial scan operations are not successful.	The DAB signals are too weak.	Change the height, direction, or placement of the antenna.
	There is no DAB coverage in your area.	
The DAB station reception is weak.	The DAB signals are too weak.	
There is noise interference (e.g. hiss, crackle, or jitter).	The antenna needs to be repositioned.	Change the height, direction, or placement of the antenna.
	The DAB signals are too weak.	
The DAB station information does not appear or is inaccurate.	The DAB station may be temporarily out of service, or the DAB station information is not provided by the DAB broadcaster.	Contact the DAB broadcaster.

# Supported devices/media and file formats

## Supported devices/ medias

### PCs

PC with Windows Media Player 11 or Windows Media Player 12 installed.

### NAS

NAS compatible with DLNA version 1.5.

### AirPlay

Supports iOS 7 or later for setup using Wireless Accessory Configuration.

AirPlay works with iPhone, iPad, and iPod touch with iOS 4.3.3 or later, Mac with OS X Mountain Lion or later, and PC with iTunes 10.2.2 or later.  
(as of July 2016)

## File format

File format the unit supporting is as follows.

### DLNA

- The unit supports playback of WAV (PCM format only), MP3, WMA, MPEG-4 AAC, FLAC, ALAC, AIFF files (1- or 2-channel audio only).
- The unit is compatible with sampling rates of up to 192 kHz/24 bit for WAV, FLAC, AIFF files, 96 kHz/24 bit for ALAC files, and 48 kHz/320 kbps for other files.
- To play back FLAC files, you need to install server software that supports sharing of FLAC files via DLNA on your PC or use a NAS that supports FLAC files.
- Digital Rights Management (DRM) contents cannot be played back.

# Specifications

## FM Tuner

FM tuning range	(U.S.A. model) 87.5 to 107.9 MHz (Other models) 87.5 to 108.0 MHz
-----------------	--

## DAB Tuner (ISX-18D)

Receive frequency band	174 to 240 MHz (Band III)
Compatibility	DAB/DAB+
Support Audio Format	MPEG 1 Layer II/MPEG-4 HE-AAC v2

## Network

Ethernet interface	100 Base-TX/10 Base-T
Connection method	Wi-Fi connection
Radio frequency band	2.4 GHz
Wireless network standards	IEEE802.11 b/g/n
Available security method	WEP, WPA2-PSK (AES), Mixed Mode
PC client function	DLNA ver.1.5 (DMR function) supported
Internet radio	vTuner supported
AirPlay	AirPlay supported

## Wi-fi

Radio Frequency (Operational Frequency)	2412 MHz to 2472 MHz
Maximum Output Power (EIRP)	19.0 dBm (79.8 mW)

## Bluetooth

<b>Bluetooth</b> version	Ver. 2.1+EDR
Supported profile	A2DP, AVRCP
Radio Frequency (Operational Frequency)	2402 MHz to 2480 MHz
Maximum Output Power (EIRP)	4.0 dBm (2.5 mW)
Compatible codecs	SBC, AAC
Wireless output	<b>Bluetooth</b> Class 2
Maximum communication range	10 m (33 ft) (without obstructions)

## Amplifier

Maximum output power	Woofer 10 W (100Hz, 10% THD) Tweeter 10 W (10kHz, 10% THD)
----------------------	---

## General

Power voltage/Frequency	(U.S.A. model) AC120 V, 60Hz (Taiwan model) AC110 to 120 V, 60 Hz (Other models) AC100 to 240V, 50/60Hz
Power consumption	10 W
Standby power consumption (Network standby off)	0.2 W
Standby power consumption (Network standby on)	Wired (Ethernet): 1.9 W Wireless (Wi-Fi/Wireless Direct/ <b>Bluetooth</b> ): 1.9 W/1.9 W/1.7 W
Weight	1.1 kg (2.4 lbs.)

## Dimensions

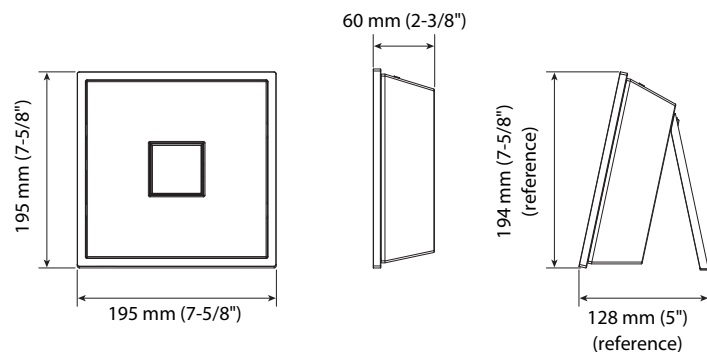

The contents of this manual apply to the latest specifications as of the publishing date.  
To obtain the latest manual, access the Yamaha website then download the manual file.

## Bluetooth

- **Bluetooth** is a technology for wireless communication between devices within an area of about 10 meters (33 ft) employing the 2.4 GHz frequency band, a band which can be used without a license.

### Handling **Bluetooth** communications

- The 2.4 GHz band used by **Bluetooth** compatible devices is a radio band shared by many types of equipment. While **Bluetooth** compatible devices use a technology minimizing the influence of other components using the same radio band, such influence may reduce the speed or distance of communications and in some cases interrupt communications.
- The speed of signal transfer and the distance at which communication is possible differs according to the distance between the communicating devices, the presence of obstacles, radio wave conditions and the type of equipment.
- Yamaha does not guarantee all wireless connections between this unit and devices compatible with **Bluetooth** function.

# Trademarks



AirPlay, iPad, iPhone, iPod, and iPod touch are trademarks of Apple Inc., registered in the U.S. and other countries.

iPad Air and iPad mini are trademarks of Apple Inc.

App Store is a service mark of Apple Inc.



DLNA™ and DLNA CERTIFIED™ are trademarks or registered trademarks of Digital Living Network Alliance. All rights reserved. Unauthorized use is strictly prohibited.



The Wi-Fi CERTIFIED logo is the certification mark of Wi-Fi Alliance.



The *Bluetooth*® word mark and logos are registered trademarks owned by Bluetooth SIG, Inc. and any use of such marks by Yamaha Corporation is under license.

Other trademarks and trade names are those of their respective owners.

## **Bluetooth protocol stack (Blue SDK)**

Copyright 1999-2014 OpenSynergy GmbH

All rights reserved. All unpublished rights reserved.

### **Explanations regarding GPL**

This product utilizes GPL/LGPL open-source software in some sections. You have the right to obtain, duplicate, modify, and redistribute this open-source code only. For information on GPL/LGPL open source software, how to obtain it, and the GPL/LGPL license, refer to the Yamaha Corporation website (<http://download.yamaha.com/sourcecodes/musiccast/>).

## **Windows™**

Windows is a registered trademark of Microsoft Corporation in the United States and other countries.

Internet Explorer, Windows Media Audio, and Windows Media Player are either registered trademarks or trademarks of Microsoft Corporation in the United States and/or other countries.

## **Android™ Google Play™**

Android and Google Play are trademarks of Google, Inc.



*Digital Audio Broadcasting*



*Digital Audio Broadcasting*

This unit supports DAB/DAB+ tuning.



MusicCast is a trademark or registered trademark of Yamaha Corporation.

**Important Notice: Guarantee Information for customers in EEA\* and Switzerland**

English

For detailed guarantee information about this Yamaha product, and Pan-EEA\* and Switzerland warranty service, please either visit the website address below (Printable file is available at our website) or contact the Yamaha representative office for your country.  
\* EEA: European Economic Area

**Remarque importante: informations de garantie pour les clients de l'EEE et la Suisse**

Français

Pour des informations plus détaillées sur la garantie de ce produit Yamaha et sur le service de garantie applicable dans l'ensemble de l'EEE ainsi qu'en Suisse, consultez notre site Web à l'adresse ci-dessous (le fichier imprimable est disponible sur notre site Web) ou contactez directement Yamaha dans votre pays de résidence. \* EEE : Espace Economique Européen

**Wichtiger Hinweis: Garantie-Information für Kunden in der EWR\* und der Schweiz**

Deutsch

Für nähere Garantie-Information über dieses Produkt von Yamaha, sowie über den Pan-EWR\*- und Schweizer Garantieservice, besuchen Sie bitte entweder die folgend angegebene Internetadresse (eine druckfähige Version befindet sich auch auf unserer Webseite), oder wenden Sie sich an den für Ihr Land zuständigen Yamaha-Vertrieb. \*EWR: Europäischer Wirtschaftsraum

**Viktigt: Garantiinformation för kunder i EES-området\* och Schweiz**

Svenska

För detaljerad information om denna Yamahaprodukt samt garantiservice i hela EES-området\* och Schweiz kan du antingen besöka nedanstående webbadress (en utskriftsvänlig fil finns på webbplatsen) eller kontakta Yamahas officiella representant i ditt land. \* EES: Europeiska Ekonomiska Samarbetsområdet

**Avviso importante: informazioni sulla garanzia per i clienti residenti nell'EEA\* e in Svizzera**

Italiano

Per informazioni dettagliate sulla garanzia relativa a questo prodotto Yamaha e l'assistenza in garanzia nei paesi EEA\* e in Svizzera, potete consultare il sito Web all'indirizzo riportato di seguito (è disponibile il file in formato stampabile) oppure contattare l'ufficio di rappresentanza locale della Yamaha. \* EEA: Area Economica Europea

**Aviso importante: información sobre la garantía para los clientes del EEE\* y Suiza**

Español

Para una información detallada sobre este producto Yamaha y sobre el soporte de garantía en la zona EEE\* y Suiza, visite la dirección web que se incluye más abajo (la versión del archivo para imprimir esta disponible en nuestro sitio web) o póngase en contacto con el representante de Yamaha en su país. \* EEE: Espacio Económico Europeo

**Belangrijke mededeling: Garantie-informatie voor klanten in de EER\* en Zwitserland**

Nederlands

Voor gedetailleerde garantie-informatie over dit Yamaha-product en de garantieservice in heel de EER\* en Zwitserland, gaat u naar de onderstaande website (u vindt een afdrukbaar bestand op onze website) of neemt u contact op met de vertegenwoordiging van Yamaha in uw land.  
\* EER: Europese Economische Ruimte

<http://europe.yamaha.com/warranty/>