

SILENT *Violin*TM

SV-200

Owner's Manual

English

Thank you for purchasing the Yamaha Silent ViolinTM. In order to obtain the maximum performance and enjoyment from your Silent ViolinTM, we urge you to read this Owner's Manual thoroughly before using the instrument. Please keep this Owner's Manual in a safe place for later reference.

Contents

Precautions	3
Main Body/Accessories	4
Nomenclature	5
Setup	7
■ Installing the Bridge	7
■ Tuning	8
■ The Shoulder Rest	8
■ Changing Strings	9
Power Supply	11
Using the Controls	12
Example Connections	15
Specifications	16

SPECIAL MESSAGE SECTION

This product utilizes batteries or an external power supply (adaptor). DO NOT connect this product to any power supply or adaptor other than one described in the manual, on the name plate, or specifically recommended by Yamaha.

This product should be used only with the components supplied or; a cart, rack, or stand that is recommended by Yamaha. If a cart, etc., is used, please observe all safety markings and instructions that accompany the accessory product.

SPECIFICATIONS SUBJECT TO CHANGE: The information contained in this manual is believed to be correct at the time of printing. However, Yamaha reserves the right to change or modify any of the specifications without notice or obligation to update existing units.

Do not attempt to service this product beyond that described in the user-maintenance instructions. All other servicing should be referred to qualified service personnel.

This product, either alone or in combination with an amplifier and headphones or speaker/s, may be capable of producing sound levels that could cause permanent hearing loss. DO NOT operate for long periods of time at a high volume level or at a level that is uncomfortable. If you experience any hearing loss or ringing in the ears, you should consult an audiologist.

IMPORTANT: The louder the sound, the shorter the time period before damage occurs.

NOTICE: Service charges incurred due to a lack of knowledge relating to how a function or effect works (when the unit is operating as designed) are not covered by the manufacturer's warranty, and are therefore the owner's responsibility. Please study this manual carefully and consult your dealer before requesting service.

ENVIRONMENTAL ISSUES: Yamaha strives to produce products that are both user safe and environmentally friendly. We sincerely believe that our products and the production methods used to produce them meet these goals. In keeping with both the letter and the spirit of the law, we want you to be aware of the following:

Battery Notice: This product MAY contain a small non-rechargeable battery which (if applicable) is soldered in place. The average life span of this type of battery is approximately five years. When replacement becomes necessary, contact a qualified service representative to perform the replacement.

This product may also use "household" type batteries. Some of these may be rechargeable. Make sure that the battery being charged is a rechargeable type and that the charger is intended for the battery being charged.

When installing batteries, do not mix old batteries with new, or with batteries of a different type. Batteries MUST be installed correctly. Mismatches or incorrect installation may result in overheating and battery case rupture.

Warning: Do not attempt to disassemble or incinerate any battery. Keep all batteries away from children. Dispose of used batteries promptly and as regulated by the laws in your area. Note: Check with any retailer of household type batteries in your area for battery disposal information.

Disposal Notice: Should this product become damaged beyond repair, or for some reason its useful life is considered to be at an end, please observe all local, state, and federal regulations that relate to the disposal of products that contain lead, batteries, plastics, etc. If your dealer is unable to assist you, please contact Yamaha directly.

NAMEPLATE LOCATION: The nameplate is located on the bottom of the product. The model number, serial number, power requirements, etc., are located on this plate. You should record the model number, serial number, and the date of purchase in the spaces provided below and retain this manual as a permanent record of your purchase.

Model

Serial No.

Purchase Date

92-BP

PLEASE KEEP THIS MANUAL

Your Silent Violin™ will give you years of reliable service if you follow the simple rules given below:

■ Location

Do not expose it to the following conditions to avoid deformation, discoloration, or more serious damage.

- Direct sunlight (e.g. near a window).
- High temperatures (e.g. near a heat source, outside, or in a car during the daytime).
- Excessive humidity.
- Excessive dust.
- Strong vibration.

■ Power Supply

- Turn the power switch OFF when not in use.

■ Turn Power OFF When Making Connections

- To avoid damage to the Silent Violin™ and other devices to which it is connected (a sound system, for example), turn the power switches of all related devices OFF prior to connecting or disconnecting audio cables.

■ Handling and Transport

- Never apply excessive force to the controls, connectors or other parts.
- Always unplug cables by gripping the plug firmly, not by pulling on the cable.
- Disconnect all cables before moving the unit.
- Physical shocks caused by dropping, bumping, or placing heavy objects on the unit can result in scratches and more serious damage.

■ Cleaning

- Clean the cabinet and panel with a dry soft cloth.
- A slightly damp cloth may be used to remove stubborn grime and dirt.
- Never use cleaners such as alcohol or thinner.
- Avoid placing vinyl objects on top of the unit (vinyl can stick to and discolor the surface).

■ Electrical Interference

- This unit contains electric circuitry and may cause interference if placed too close to radio or television receivers. If this occurs, move it further away from the affected equipment.

YAMAHA is not responsible for damage caused by improper handling or operation.

Information for Users on Collection and Disposal of Old Equipment and used Batteries



These symbols on the products, packaging, and/or accompanying documents mean that used electrical and electronic products and batteries should not be mixed with general household waste. For proper treatment, recovery and recycling of old products and used batteries, please take them to applicable collection points, in accordance with your national legislation and the Directives 2002/96/EC and 2006/66/EC.

By disposing of these products and batteries correctly, you will help to save valuable resources and prevent any potential negative effects on human health and the environment which could otherwise arise from inappropriate waste handling.

For more information about collection and recycling of old products and batteries, please contact your local municipality, your waste disposal service or the point of sale where you purchased the items.



[For business users in the European Union]

If you wish to discard electrical and electronic equipment, please contact your dealer or supplier for further information.



[Information on Disposal in other Countries outside the European Union]

These symbols are only valid in the European Union. If you wish to discard these items, please contact your local authorities or dealer and ask for the correct method of disposal.

Note for the battery symbol (bottom two symbol examples):

This symbol might be used in combination with a chemical symbol. In this case it complies with the requirement set by the Directive for the chemical involved.

Cd

Main Body/Accessories

After opening the packaging, please check that all the parts listed below are included.

- Violin

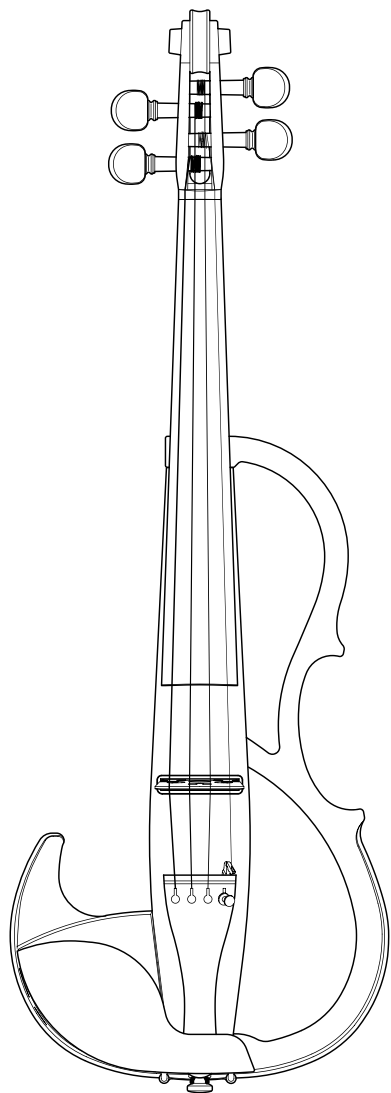

- Bridge

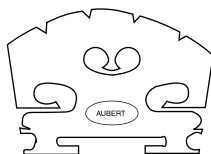

- 6F22 (S-006P) 9V battery x 1

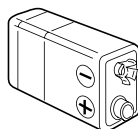

- Stereo earphones

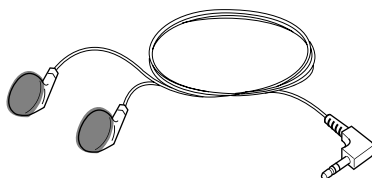

Nomenclature

● Front

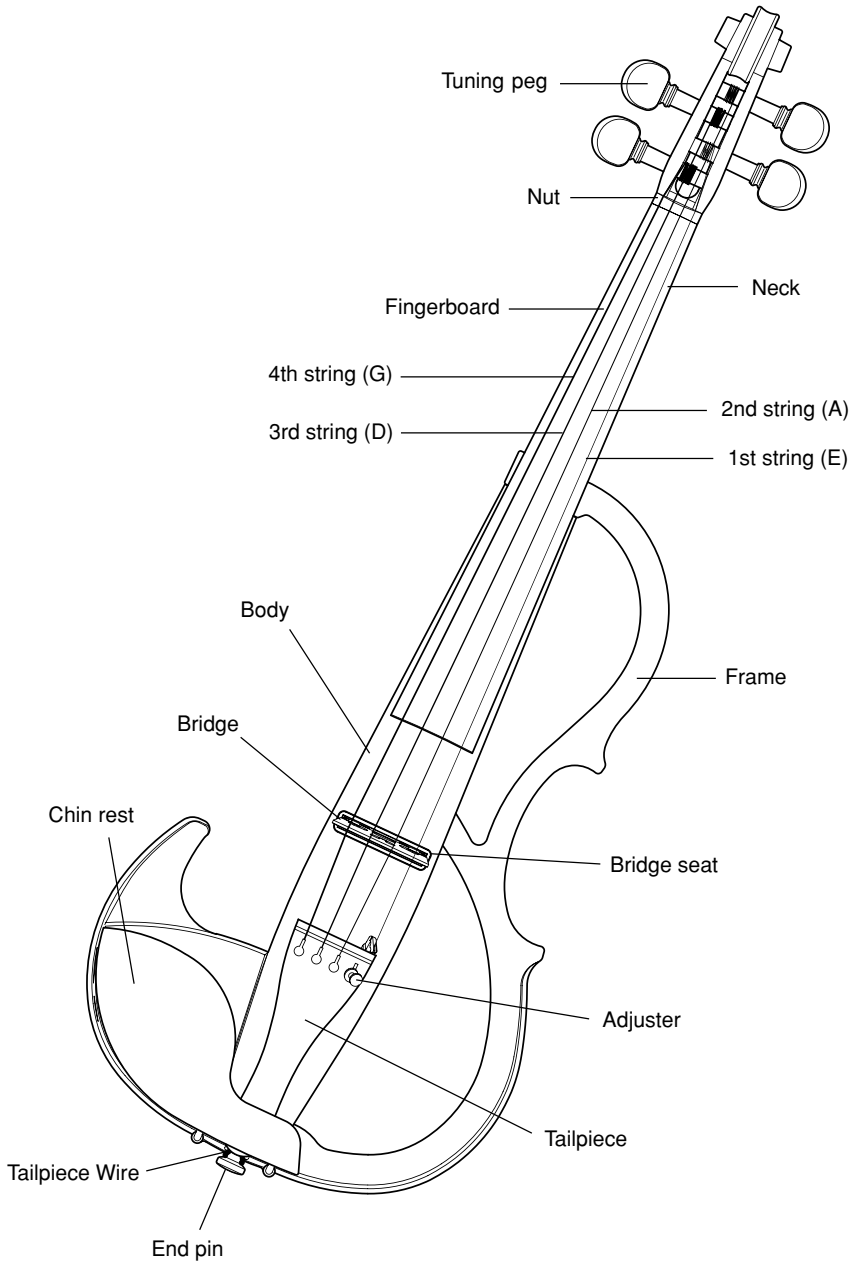

● Controls

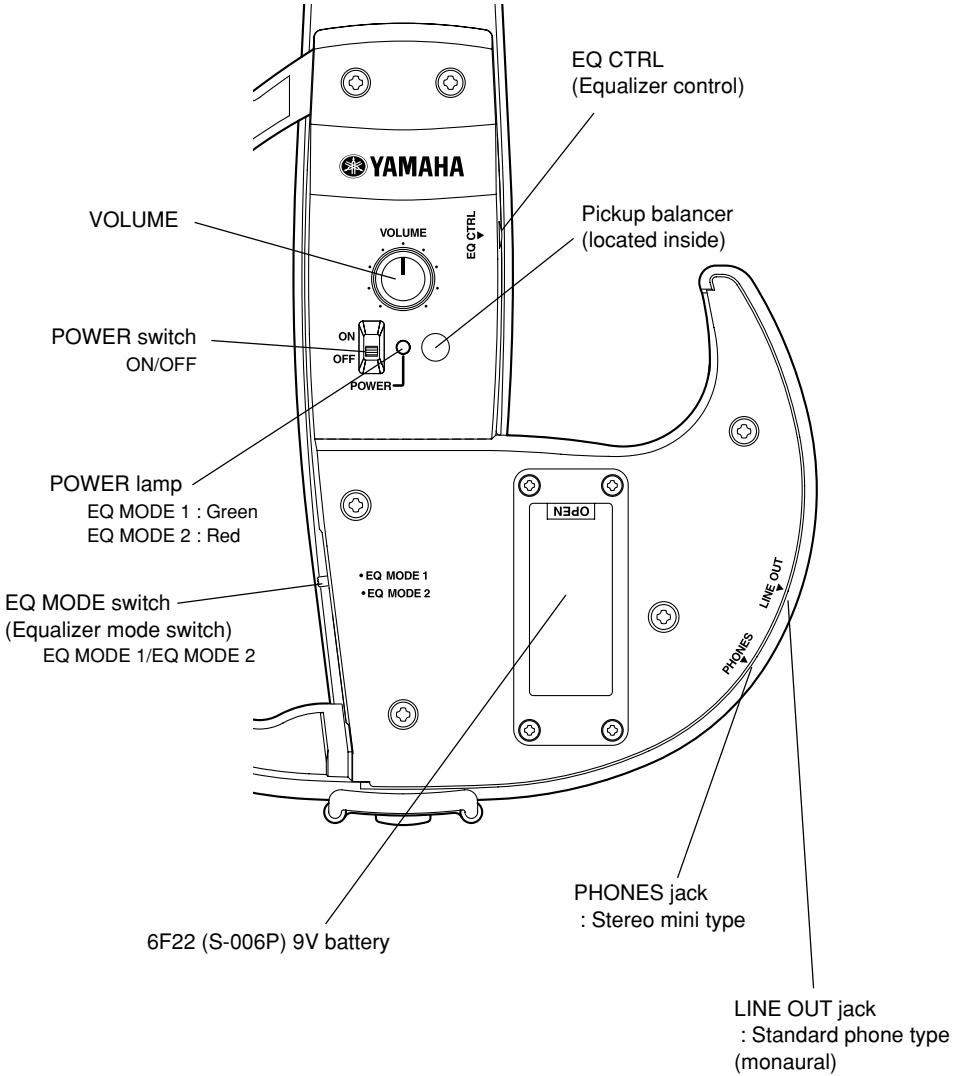

Setup

■ Installing the Bridge

The Silent Violin™ is shipped from the factory with the bridge unfitted. First, set up the bridge and then proceed with tuning.

- The lower side of the bridge supports the 1st string (E), the higher side supports the 4th string (G). Make sure the bridge is placed properly, then set the bridge in the bridge seat. (Make sure the logo side of the bridge is facing the tailpiece.)
- Make sure the entire underside of the bridge's legs is in contact with the pickup. Also, make sure that the bridge does not slide off of the Bridge Seat or that its legs are touching the sides of the Bridge Seat. Doing so will result in deteriorated sound quality.
- Ensure that the tailpiece side of the bridge stands vertically. If it leans to one side, use both hands to adjust. Make sure that each string passes over the corresponding slits in the bridge.
 - * **Playing the violin with a leaning bridge may result in damage to the bridge or a deterioration in sound quality.**

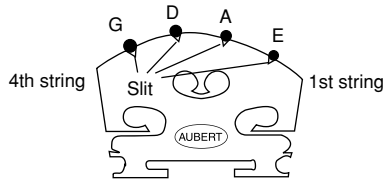

[Looking from the tailpiece]

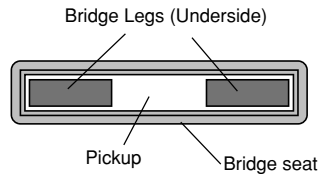

[Placing the Bridge's Legs]

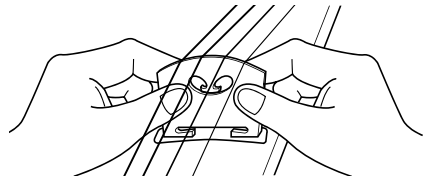
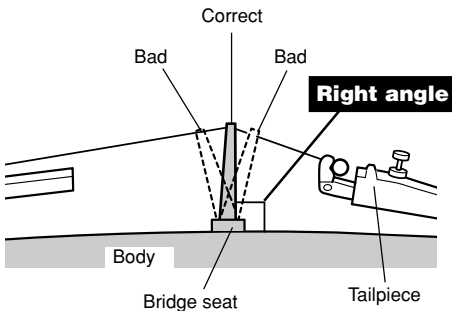

[Bridge is placed vertically]

■ Tuning

- The strings are tuned to the following pitches. The 1st string is tuned to E, the 2nd string to A, the 3rd string to D, and the 4th string to G.
Use a piano, tuning fork, tuner, etc., and adjust the pitch of each string using the tuning pegs. When rotating the peg, apply firm pressure towards the head stock.
- After tuning is complete, make sure that the tailpiece side of the bridge is still properly aligned. If the bridge is leaning in either direction, slightly loosen the strings and carefully re-align the bridge using both hands.
- An adjuster is provided on the 1st string for fine tuning the string's pitch.

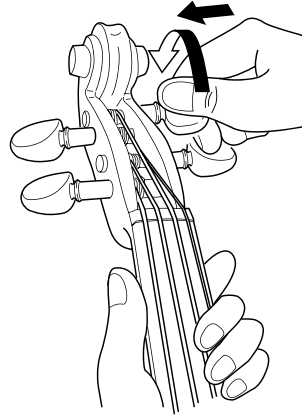

- Do not over-tighten or over-loosen the adjuster. It may result in damage to the instrument or be a source of noise during performance.
- When removing the bridge from the instrument, make sure the adjuster does not come into contact with the instrument so as to prevent scratching the instrument's body.

■ The Shoulder Rest

Most standard size (4/4) violin rests can be attached to the body of the Silent Violin™.

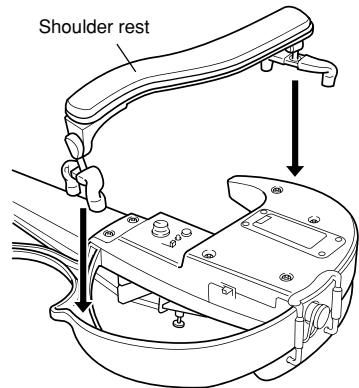

Natural wood is used for some parts in this instrument. Depending upon the manner in, or the circumstance under which the instrument is used, your fingers, body or clothes may become blackened or the wood parts may change color. If your fingers or body become blackened, it is not harmful but please wash with water thoroughly. The maker takes no responsibility for any discoloration of clothes or wood parts.

■ Changing Strings

As the strings get old, sound quality will gradually decrease, and it will become difficult to tune the instrument. Change the strings as soon as you think they are getting old.

Always change the strings one at a time, even if all strings must be changed.

- The end of the strings are sharp and can cut fingers. Use caution when changing strings.
- When changing or adjusting strings, do not put your face close to the instrument. The string may suddenly break resulting in eye or other unexpected injuries.

1 Before you string the instrument, set the adjuster so that it is in the middle of its adjustment range.
(on the 1st string only)

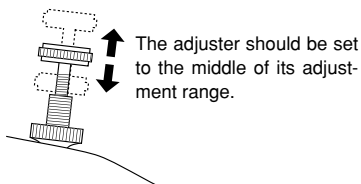

2 Attach the string to the tailpiece.

- On the **4th (G), 3rd (D) and 2nd (A) strings**, from above the tailpiece insert the ball end of the string into the hole on the tailpiece and hook the ball end into the notch string hole.
- On the **1st (E) string**, hook the ball end of the string into the notch on the adjuster. At this time, make sure that the ball is properly seated in the notch on the adjuster.

[Attaching the 4th (G), 3rd (D) and 2nd (A) strings]

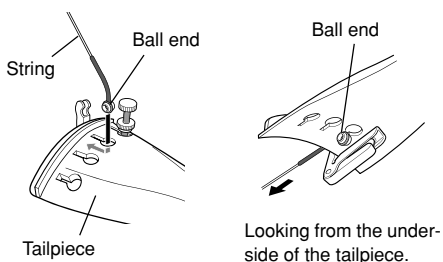

Caution

- Make sure that the tailpiece wire is properly positioned around the endpin.

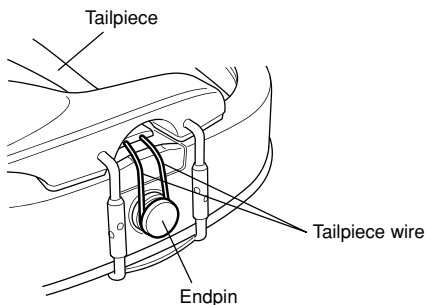

[Attaching the 1st (E) string]

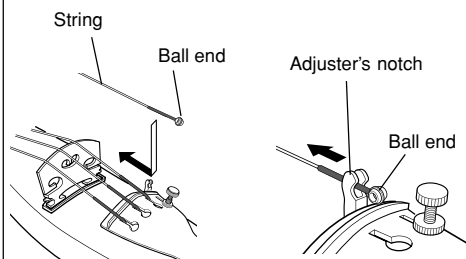

3 Insert the string into the hole on the peg and wind the string onto the peg.

- On the **1st (E) and 2nd (A) strings**, make two winds toward the 3rd and 4th string side of the peg, then wind back over those winds and to the opposite side of the string hole.
- On the **3rd (D) and 4th (G) strings**, make two winds toward the 1st and 2nd string side of the peg, then wind back over those winds and to the opposite side of the string hole.

Next, make sure that the bridge does not fall over as you wind the strings. Ensure that the strings pass over the corresponding slits on the top of the bridge. (Make sure that the bridge is standing vertically.)

The 1st string (E) has a protective tube on it. Make sure the tube is placed on the bridge as shown in the illustration.

4 Use a piano, tuning fork, tuner, etc., and adjust the pitch of each string using the tuning pegs.

5 Use the adjuster on the 1st string for fine tuning of string's pitch.

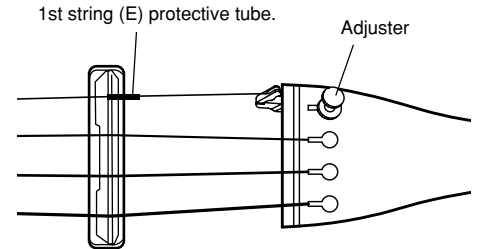
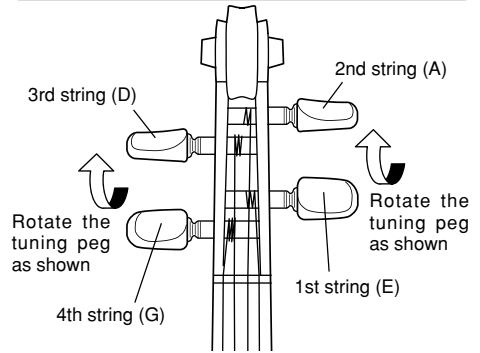
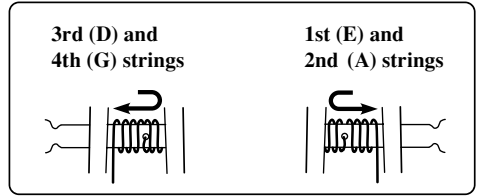

Caution • Do not over-tighten or over-loosen the adjuster. It may result in damage to the instrument or be a source of noise during performance.

• When the instrument is not going to be used for an extended period of time, loosen the strings until the pitch drops a whole tone.

Power Supply

The Silent Violin™ is powered by a single 6F22 (S-006P) 9V battery. Before installing the battery, make sure that the POWER switch (ON/OFF) located on the backside of the instrument is in its OFF position.

- 1 Open the battery case located on the backside of the instrument by pulling the tab labeled “OPEN” toward you, then open the battery compartment cover.
- 2 Insert the supplied battery (S-006P:6F22) into the battery compartment. Take careful note of the polarity markings (+/-) as shown in the illustration when inserting the battery.
- 3 Close the battery compartment cover and push the battery case all the way back into the instrument body.

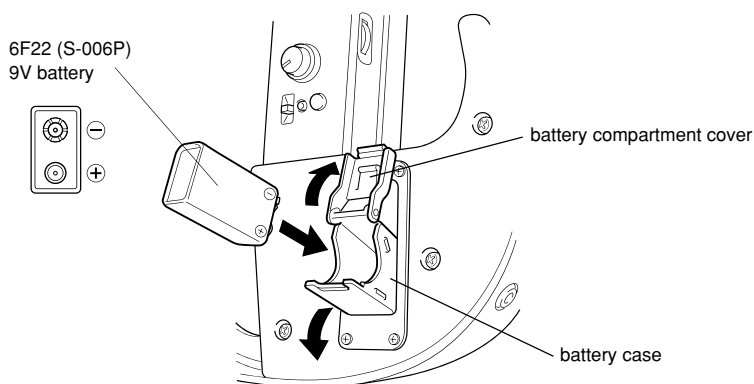

* For customers in the Netherlands

Bij dit produkt zijn batterijen geleverd. Wanneer deze leeg zijn, moet u ze niet weggooien maar inleveren als KCA.



When battery power is depleted, the POWER lamp will go out and sound will not be produced. When this occurs, please take careful note of the following precautions and replace the battery.

- When replacing the battery, please purchase a replacement battery that is the same type as the supplied battery (make sure the size and dimensions, plus the terminal design are the same). Depending upon the manufacturer, designs may differ slightly. A different type of battery may be difficult to insert into the battery case and may result in damaging the instrument. Also, even if the battery can be inserted, its use may result in fire, poor operation, etc. due to poor contact with the battery terminals.
- Always follow the +/- signs when inserting the battery. Improper insertion may result in fire.
- To prevent possible damage to the unit due to battery leakage and unnecessary power drain, remove the battery from the unit when it is not going to be used for an extended period of time.

Using the Controls

1 POWER Switch

Used to switch the power ON/OFF.

2 VOLUME

Used to control the volume. Rotate the knob to the right to increase the volume.

3 EQ CTRL (Equalizer Control)

The SV-200 Silent Violin™ is equipped with an Equalizer Control that has the ability to isolate and control the upper partials of the harmonics that are created when the violin is played.

This function offers effective adjustment of the Silent Violin™'s tone, response, etc.

We recommend a setting of about “8” but please adjust the tone to your own personal preference.

4 EQ MODE Switch

Used to set the equalizer to one of its two EQ MODE types.

• EQ MODE 1

This mode is designed to deliver optimum tone from the instrument. We recommend that you adjust the EQ CTRL to any level you like.

• EQ MODE 2

Select this mode when you want to use the tone produced directly from the pickup. This mode delivers the uncolored tone directly from the pickup.

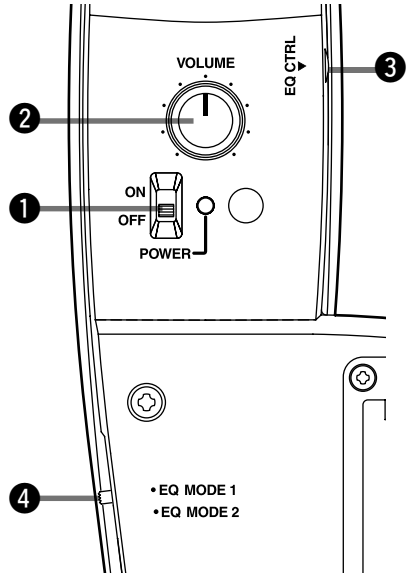

[Circuit block diagram]

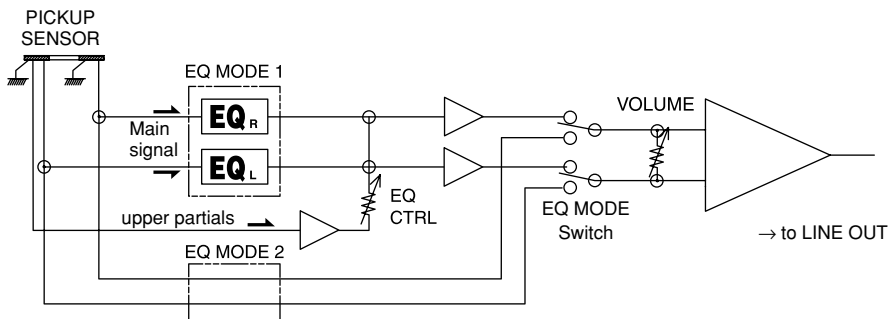

5 Pickup Balancer

The Silent Violin™'s pickup system consists of separate sensors for low strings and high strings. Depending upon the type of strings and your playing style, you might want to adjust the balance of the high and low sensors. If so, please use the following procedure.

- 1 Remove the rubber cover located next to the POWER lamp on the rear control section of the instrument.
* **Do not lose this cover.**
- 2 Use a non-conductive screwdriver (made of plastic or resin so it does not conduct electricity) to turn the balance control located inside the hole to adjust the pickup balance.
Use a pair of stereo earphones as a monitor and adjust the their position so that the most natural balance between the two pickups is attained.
Turn to the right (clockwise) to increase the volume of the high strings sensor (R), turn to the left (counter-clockwise) to increase the volume of the low strings sensor (L).
* **Do not turn the Pickup Balancer control too far. Doing so may result in damage to the controller.**
- 3 After adjustment is complete, replace the rubber cover.

HINT We recommend that the sound from the LINE OUT jack be checked as well when performing this adjustment.

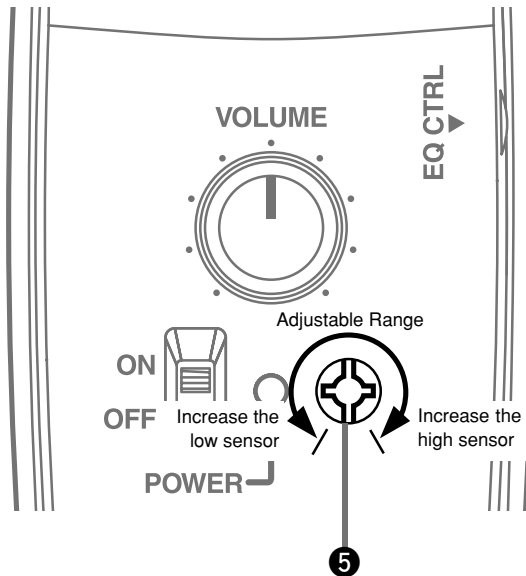

6 LINE OUT jack

This jack (standard phone, monaural) delivers signal output of the Silent Violin™'s tone.

Use an audio cable to connect the instrument to the audio input jack of powered speakers, mixing console, cassette player, etc. to listen from external audio equipment or recording. You can also connect this jack to the INPUT jack on an electronic tuner and tune the Silent Violin™ like an electronic instrument using the instrument's output signal.

7 PHONES jack

Connect a pair of stereo earphones, etc. to this jack (stereo mini).

When heard through the earphones, the violin's strings will appear to be spread out between the left and right earphones with the low strings positioned toward the left (L) channel and the high strings toward the right (R). This provides the player with a more natural sound experience when monitoring through the headphones.

Make sure the L (left ear) and R (right ear) earphones are placed in the correct ears.

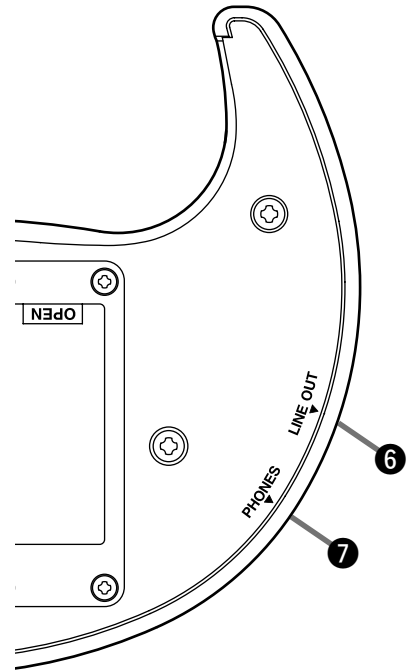

- **Do not operate at high volume levels when using earphones. Doing so can lead to irreparable damage to your hearing.**
- **Before connecting the Silent Violin™ to any external devices, make sure that the power of all external devices is turned OFF. Set the volume level of the Silent Violin™ and any external audio sources to the minimum level before connecting anything. High volume settings could cause damage to the equipment and your hearing.**
- **If a connection cord is unplugged while the power is ON, it may result in damage to the equipment. The sudden shock to your ears may be great, so please use with care.**
- **Be careful not to step on the cord. The cord may break, equipment may be damaged, and this may cause a substantial shock to your ears.**

Example Connections

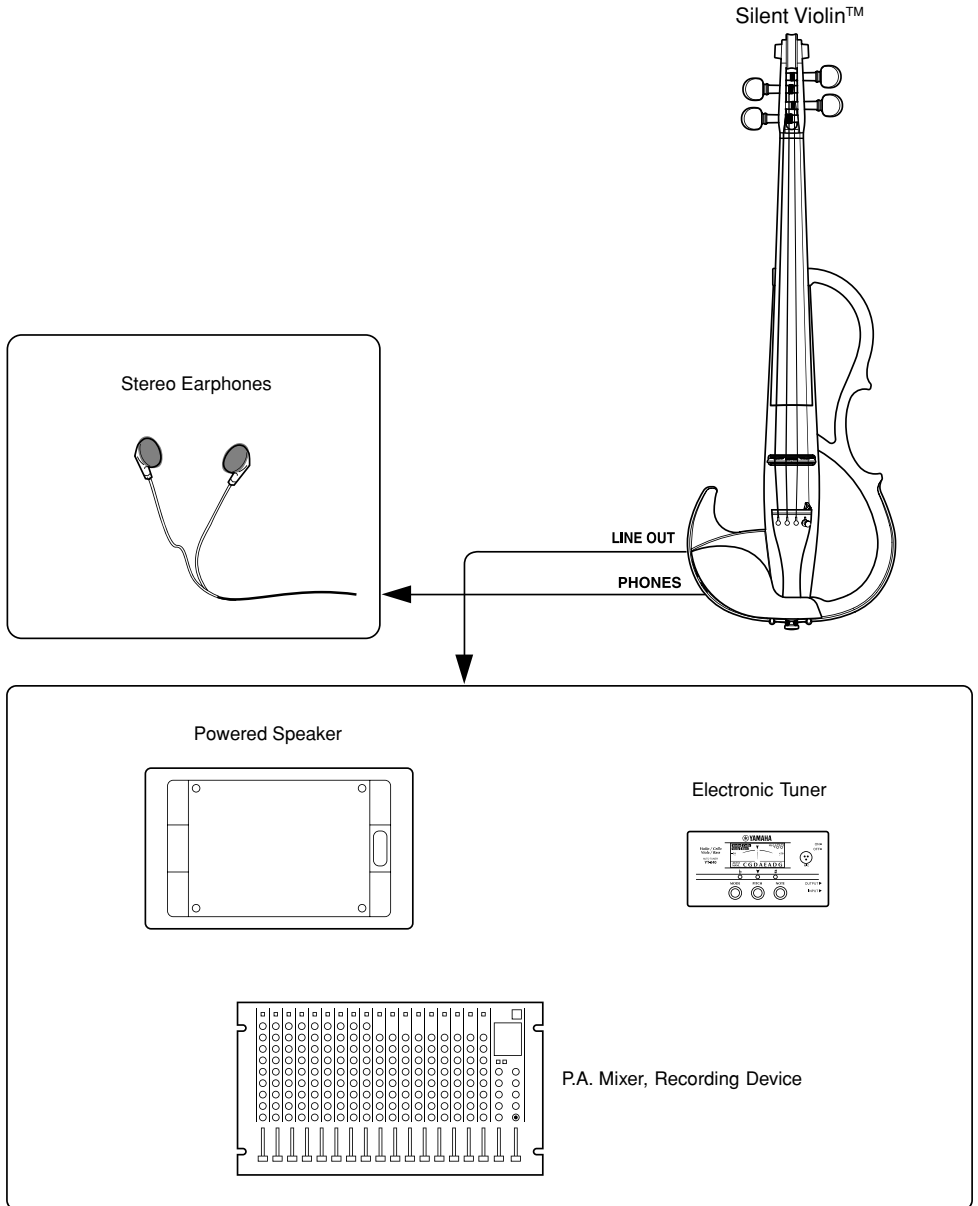

When connecting the instrument to external audio equipment, check the jack size and make sure to use a plug size that corresponds to the jack being used, and properly connect the cable to the jack.

Specifications

Neck	Hard Maple
Body	Spruce
Fingerboard/Tuning Pegs	Ebony
Bridge	Hard Maple (Aubert)
Frame	ABS Resin
Chin Rest/Tailpiece	Ebony
Adjuster	1st string (Wittner)
Strings	Ball-end type (D'Addario : Zyex)
Sensor	Stereo Piezo pick-up (underneath the bridge)
Connectors/Controls	<ul style="list-style-type: none">• Headphone Output• EQ CTRL (Equalizer Control)• LINE OUT• Volume• EQ MODE Switch (EQ MODE 1/EQ MODE 2)• POWER Switch (ON/OFF)
Power	6F22(S-006P)/6LR61 9V battery x1
Battery Life (Continuous Use)	Using Manganese battery : approximately 12 hours Using Alkaline battery : approximately 24 hours
String Length	328 mm (12-15/16")
Dimensions	597 (L) x 210 (W) x 116 (H) mm 23-1/2" (L) x 8-1/4" (W) x 4-9/16" (H)
Weight (with battery)	620g (1 lbs. 6 oz.)

* Design and specifications are subject to change without notice.

