

YAMAHA RX-450 *RS*

45W + 45W (8Ω) RMS Output Power, 0.04% THD, 20-20,000 Hz

16-Station Random Preset Tuning

IF Count Direct PLL Synthesizer Tuning System

Continuously Variable Loudness Control

High Dynamic Power, Low Impedance Drive Capability

CD Direct Switch

Bass Extension Switch

Remote Control Capability

Thank you for selecting the YAMAHA stereo receiver.



CAUTION

RISK OF ELECTRIC SHOCK

DO NOT OPEN

CAUTION: TO REDUCE THE RISK OF ELECTRIC SHOCK, DO NOT REMOVE COVER (OR BACK). NO USER-SERVICEABLE PARTS INSIDE. REFER SERVICING TO QUALIFIED SERVICE PERSONNEL.



OWNER'S MANUAL

CONTENTS

Safety Instructions	2
Caution	3
Warning	3
Supplied Accessories	3
Connections	4
Operations	6
Tuning Operations	8
Remote-Control Transmitter	10
Notes about the Remote Control Transmitter	11
Troubleshooting	11
Specifications	12

IMPORTANT!

Please make a note of the serial number of this unit in the space indicated below.

Model:
Serial No.:

The serial number is inscribed on the rear of the unit.
Keep this Owner's Manual in a safe place for future reference.

WARNING

To reduce the risk of fire or electric shock, do not expose this appliance to rain or moisture.

• Explanation of Graphical Symbols



The lightning flash with arrowhead symbol, within an equilateral triangle, is intended to alert you to the presence of uninsulated "dangerous voltage" within the product's enclosure that may be of sufficient magnitude to constitute a risk of electric shock to persons.



The exclamation point within an equilateral triangle is intended to alert you to the presence of important operating and maintenance (servicing) instructions in the literature accompanying the appliance.

SAFETY INSTRUCTIONS

- 1 Read Instructions – All the safety and operating instructions should be read before the appliance is operated.
- 2 Retain Instructions – The safety and operating instructions should be retained for future reference.
- 3 Heed Warnings – All warnings on the appliance and in the operating instructions should be adhered to.
- 4 Follow Instructions – All operating and other instructions should be followed.
- 5 Water and Moisture – The appliance should not be used near water – for example, near a bathtub, washbowl, kitchen sink, laundry tub, in a wet basement, or near a swimming pool, etc.
- 6 Carts and Stands – The appliance should be used only with a cart or stand that is recommended by the manufacturer.
- 6A An appliance and cart combination should be moved with care. Quick stops, excessive force, and uneven surfaces may cause the appliance and cart combination to overturn.
- 7 Wall or Ceiling Mounting – The appliance should be mounted to a wall or ceiling only as recommended by the manufacturer.
- 8 Ventilation – The appliance should be situated so that its location or position does not interfere with its proper ventilation. For example, the appliance should not be situated on a bed, sofa, rug, or similar surface, that may block the ventilation openings; or placed in a built-in installation, such as a bookcase or cabinet that may impede the flow of air through the ventilation openings.
- 9 Heat – The appliance should be situated away from heat sources such as radiators, stoves, or other appliances that produce heat.
- 10 Power Sources – The appliance should be connected to a power supply only of the type described in the operating instructions or as marked on the appliance.
- 11 Power-Cord Protection – Power-supply cords should be routed so that they are not likely to be walked on or pinched by items placed upon or against them, paying particular attention to cords at plugs, convenience receptacles, and the point where they exit from the appliance.
- 12 Cleaning – The appliance should be cleaned only as recommended by the manufacturer.
- 13 Nonuse Periods – The power cord of the appliance should be unplugged from the outlet when left unused for a long period of time.
- 14 Object and Liquid Entry – Care should be taken so that objects do not fall into and liquids are not spilled into the inside of the appliance.
- 15 Damage Requiring Service – The appliance should be serviced by qualified service personnel when:

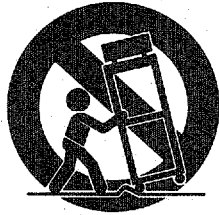

- A. The power-supply cord or the plug has been damaged; or
- B. Objects have fallen, or liquid has been spilled into the appliance; or
- C. The appliance has been exposed to rain; or
- D. The appliance does not appear to operate normally or exhibits a marked change in performance; or
- E. The appliance has been dropped, or the cabinet damaged.
- 16 Servicing – The user should not attempt to service the appliance beyond those means described in the operating instructions. All other servicing should be referred to qualified service personnel.
- 17 Power Lines – An outdoor antenna should be located away from power lines.
- 18 Grounding or Polarization – The precautions that should be taken so that the grounding or polarization is not defeated.
- 19 Outdoor Antenna Grounding – If an outside antenna is connected to this unit, be sure the antenna system is grounded so as to provide some protection against voltage surges and built up static charges. Section 810 of the National Electrical Code, ANSI/NFPA No. 70-1984, provides information with respect to proper grounding of the mast and supporting structure, grounding of the lead-in wire to an antenna discharge unit, size of grounding conductors, location of antenna discharge unit, connection to grounding electrodes, and requirements for the grounding electrode.

EXAMPLE OF ANTENNA GROUNDING

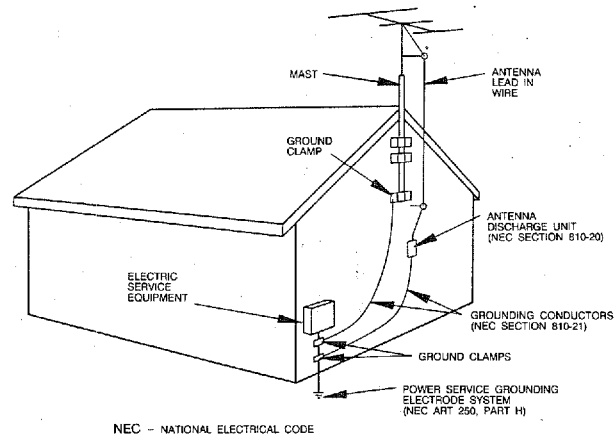

Note to CATV system installer:
 This reminder is provided to call the CATV system installer's attention to Article 820-22 of the NEC that provides guidelines for proper grounding and, in particular, specifies that the cable ground shall be connected to the grounding system of the building, as close to the point of cable entry as practical.

CAUTION: READ THIS BEFORE OPERATING YOUR UNIT

- 1 To ensure the finest performance, please read this manual carefully. Keep it in a safe place for future reference.
- 2 Install your unit in a cool, dry, clean place – away from windows, heat sources, and too much vibration, dust, moisture or cold. Avoid sources of hum (transformers, motors). To prevent fire or electrical shock, do not expose to rain and water.
- 3 Do not operate the unit upside-down. It may overheat, possibly causing damage.
- 4 Never open the cabinet. If a foreign object drops into the set, contact your dealer.
- 5 Do not use force on switches, knobs or cords. When moving the set, first turn the unit off. Then gently disconnect the power plug and the cords connecting to other equipment. Never pull the cord itself.
- 6 Do not attempt to clean the unit with chemical solvents; this might damage the finish. Use a clean, dry cloth.
- 7 Always set the volume control to “-∞” before starting the audio source play; increase the volume gradually to an appropriate level after the play is started.
- 8 To prevent lightning damage, pull out the power cord and remove the antenna cable during an electrical storm.
- 9 Be sure to read the “Troubleshooting” section on common operating errors before concluding that your unit is faulty.
- 10 Do not connect audio equipment to the AC outlets on the rear panel if that equipment requires more power than the outlets are rated to provide.

WARNING: CHEMICAL CONTENT NOTICE!

The solder used in the manufacture of this product contains LEAD. In addition, the electrical/electronic and/or plastic (where applicable) components may also contain traces of chemicals found by the California Health and Welfare Agency (and possibly other entities) to cause cancer and/or birth defects or other reproductive harm.

DO NOT REMOVE ANY ENCLOSURE COMPONENTS!

There are no user serviceable parts inside. All service should be performed by a service representative authorized by Yamaha to perform such service.

IMPORTANT MESSAGE: Yamaha strives to produce products that are both user safe and environmentally “friendly”. We sincerely believe that our products meet these goals. However, in keeping with both the spirit and the letter of various statutes we have included the messages shown above and others in various locations in this manual.

SUPPLIED ACCESSORIES

After unpacking, check that the following parts are contained.

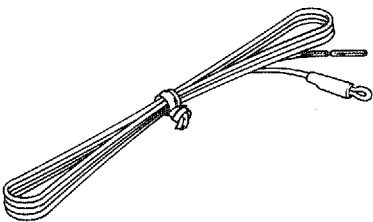

Indoor FM Antenna

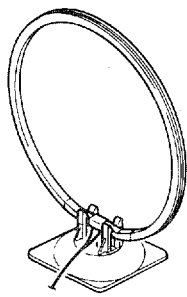

AM Loop Antenna

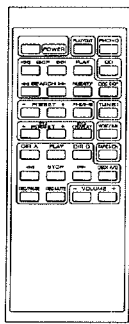

Remote Control Transmitter

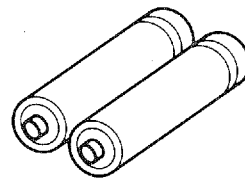

Batteries (size “AAA”, R03)

CONNECTIONS

Before attempting to make any connections to or from this unit, be sure to first switch OFF the power to this unit and to any other components to which connections are being made.

AUDIO CONNECTIONS

When making connections between this unit and other components, be sure all connections are made correctly, that is to say L (left) to L, R (right) to R, "+" to "+" and "-" to "-". Also, refer to the owner's manual for each component to be connected to this unit.

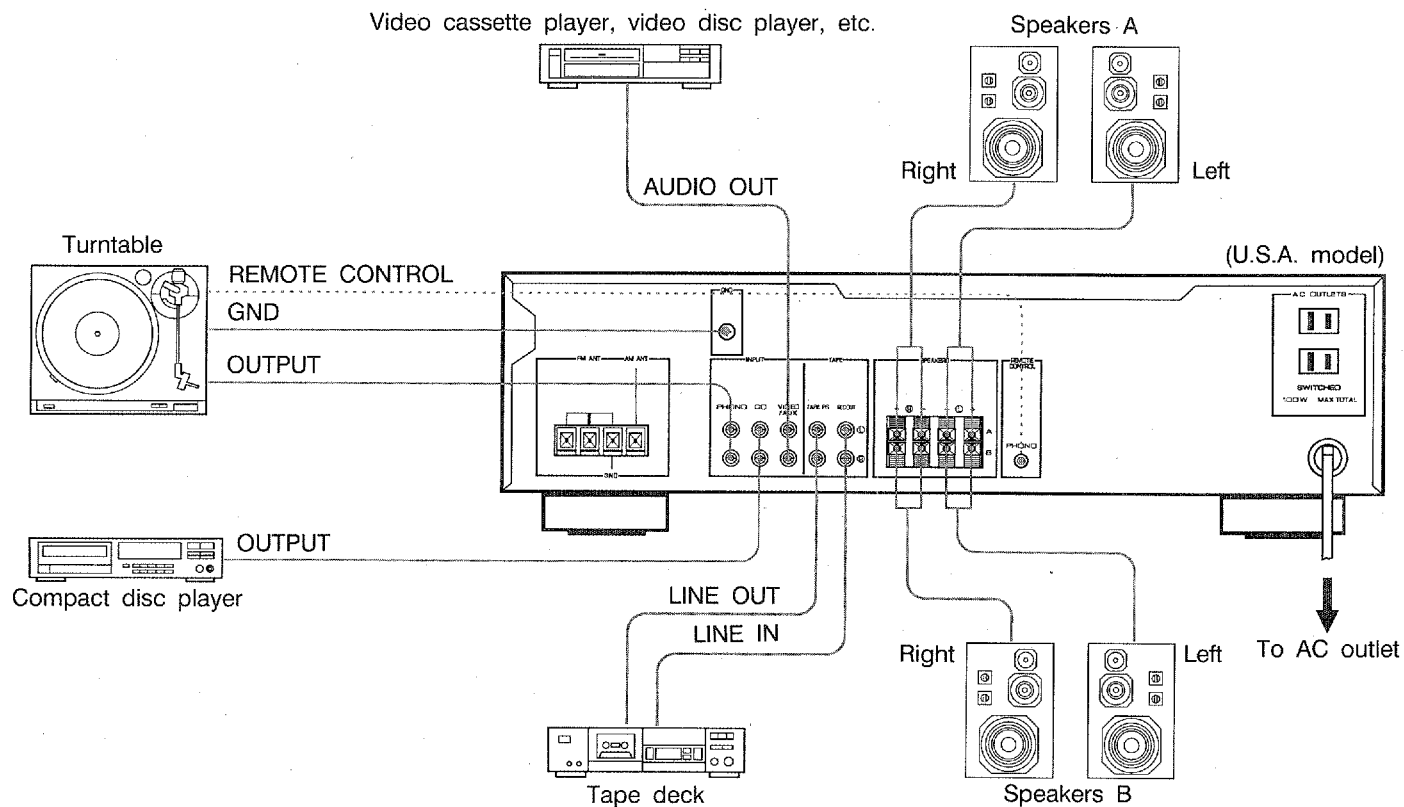

Connecting speaker systems

- One or two speaker systems can be connected to this unit. If you connect only one speaker system, connect it to either **SPEAKERS A** or **B** terminals.
- Use speakers with the specified impedance shown on the rear of this unit.
- **How to Connect:**
Connect the **SPEAKERS** terminals to your speakers with wire of the proper gauge, cut to be as short as possible. Press and hold the **SPEAKERS** terminal tabs, then insert the bare wires and secure them by releasing the tabs. If these connections are faulty, no sound will be heard from the speakers. Make sure that the polarity of the speaker wires is correct, that is, + and - markings are observed. If these wires are reversed, the sound will be unnatural and will lack bass. Do not let the bare speaker wires touch each other as this could damage this unit and/or speakers.

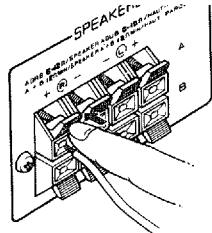

About the accessory terminals

- **AC OUTLETS**
(U.S.A., Canada, General and Europe models) 2 SWITCHED OUTLETS
(Australia and U.K. models) 1 SWITCHED OUTLET
Use these to connect the power cords from your components to this unit.
The power to the **SWITCHED** outlets is controlled by this unit's **POWER** switch. They will supply power to any component whenever this unit is turned on.
The maximum power (total power consumption of components) that can be connected to the **SWITCHED AC OUTLETS** is 100 watts.
- **REMOTE CONTROL (PHONO) connector**
If you have a YAMAHA turntable with the **ERS** mark, connect it to this connector. This connection allows you to control the turntable from the provided remote control transmitter.
- **GND terminal**
Connecting the ground wire of the turntable to this terminal will produce minimum humming, but in some cases better results may be obtained with the ground wire disconnected.

ANTENNA CONNECTIONS

- Each antenna should be connected to the designated terminals correctly, referring to the following figure.
- Both AM and FM indoor antennas are included with this unit. In general, these antennas will probably provide sufficient sensitivity. Furthermore, a properly installed outdoor antenna will give clearer reception than an indoor one. If you experience poor reception quality, an outdoor antenna may result in improvement.

U.S.A., CANADA, U.K., AUSTRALIA AND GENERAL MODELS

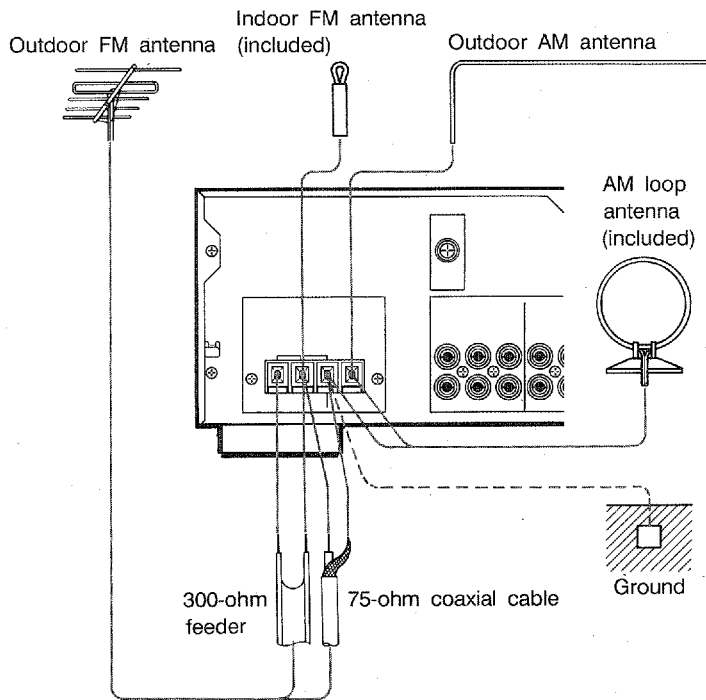

EUROPE MODEL

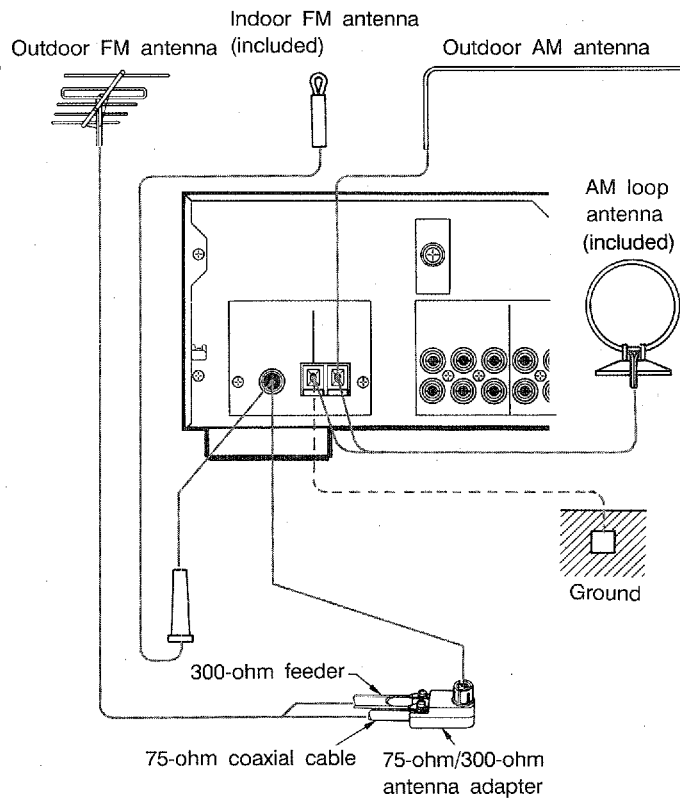

Connecting the AM loop antenna

1

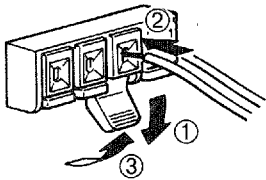

2

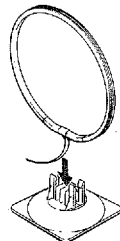

3

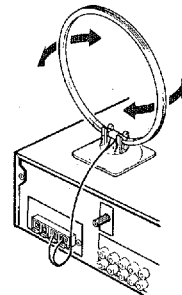

Orient so that the best reception is obtained.

* The antenna may be hung on a wall.

* The AM loop antenna should be kept being connected, even if an outdoor AM antenna is connected to this unit.

GND terminal

For maximum safety and minimum interference, connect the **GND** terminal to a good earth ground if practical. A good earth ground is a metal stake driven into moist earth.

Notes

- When connecting the indoor FM antenna (for Europe model), make sure that the grooved part of the connector hole is facing downward.
- If you need an outdoor FM antenna to improve FM reception quality, either 300-ohm feeder or coaxial cable may be used. In locations troubled by electrical interference, coaxial cable is preferable.

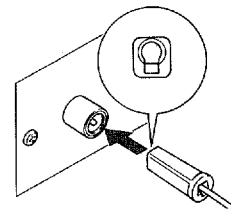

OPERATIONS

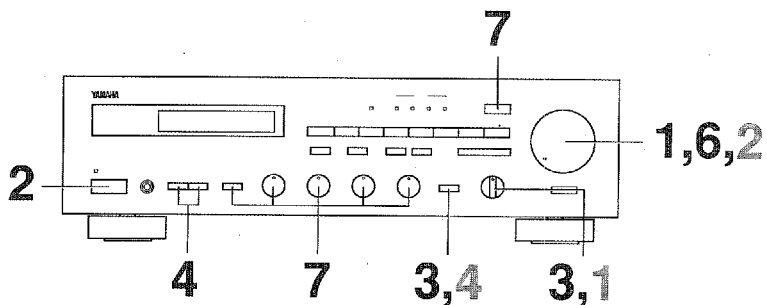

To listen to an audio source

- 1**

Set to the "∞" position.
- 2**
- 3** Select the source you want to listen to.

* If you want to listen to the tape deck;

When not listening to the tape deck, set this switch so that the indicator does not illuminate.
- 4** Select the speaker system to be used by pressing the **SPEAKERS** switches. (Refer to the next page for details.)
- 5** Play the source.

- 6**

Adjust to the desired output level.
- 7** If desired, adjust the **BALANCE, BASS, TREBLE, LOUDNESS** controls and the **BASS EXTENSION** switch. (Refer to the next page for details.)

To record a source to audio tape

- 1** Select the source to be recorded.
- 2** Play the source and then turn the **VOLUME** control up to confirm the input source.
- 3** Set the tape deck in the recording mode.
- 4** If your tape deck has three head monitoring capability you can monitor the signal just recorded.

Note
Adjusting the **VOLUME, LOUDNESS, BASS, TREBLE** and **BALANCE** controls during recording has no effect on the material being recorded.

Adjusting the BALANCE control

Adjust the balance of the output volume to the left and right speakers to compensate for sound imbalance caused from the speaker settings or the listening room condition.

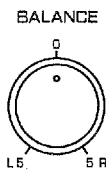

Selecting the SPEAKER system

Because one or two speaker systems can be connected to this unit, the **SPEAKERS** switches allow you to select speaker system A or B, or both at once.

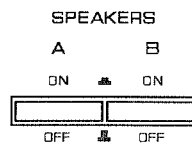

Adjusting the BASS and TREBLE controls

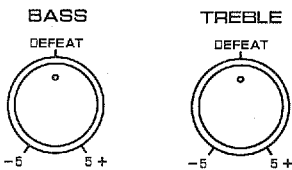

BASS : Turn this clockwise to increase (or counter-clockwise to decrease) the low frequency response.

TREBLE : Turn this clockwise to increase (or counter-clockwise to decrease) the high frequency response.

Adjusting the continuous variable LOUDNESS control

This control provides compensation for the human ears' loss of sensitivity to high and low-frequency ranges at low volume. This control is adjustable to retain full tonal range at any volume level.

1 LOUDNESS

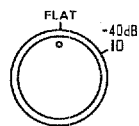

Set to the "FLAT" position.

2 VOLUME

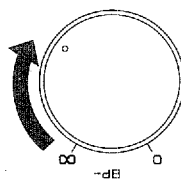

Set to the loudest listening level that you would listen to.

3 LOUDNESS

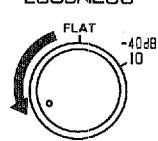

Turn until the volume level is reduced to a desired level without losing natural tone.

Using the BASS EXTENSION switch

You can boost bass frequency response by setting this switch to the "ON" position.



Using the CD DIRECT switch

You can enjoy purer CD sound by setting this switch to the "ON" position. Because, by doing so, the CD input signal is output directly, bypassing the **LOUDNESS**, **BALANCE** controls, etc. therefore avoiding any "muddying" caused by circuit routing.

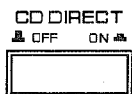

When you listen with headphones

Connect the headphones to the **PHONES** jack. When listening with headphones privately, set both the **SPEAKERS A** and **B** switches to the OFF position.

PHONES

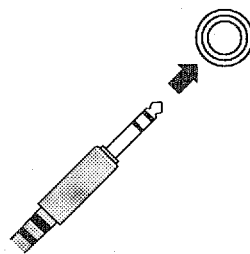

TUNING OPERATIONS

Normally, if station signals are strong and there is no interference, quick automatic-search tuning is possible. However, if signals of the station you want to select are weak, you must tune to it manually.

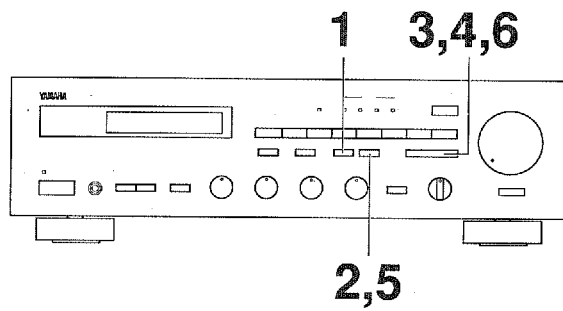

1 Select the reception band (FM or AM) while watching the display.

2

3

4 If the station where tuning search stopped is not the desired one, press again.

5 If the tuning search does not stop at the desired station;

6

* You can tune to the desired station manually.

* To continue tuning search, press and hold the button.

Display information

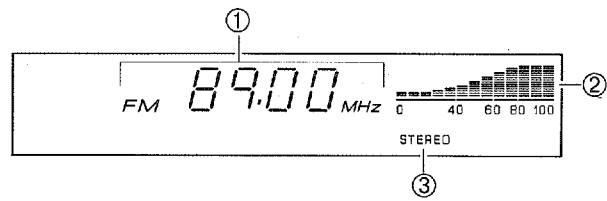

- ① Displays the band and frequency of the received station.
- ② Indicates the signal level of the received station.
- ③ Illuminates when an FM stereo broadcast with sufficient signal strength is received.

Note

If you tune to a FM station manually, it is received in monaural automatically to increase the signal quality.

PRESET TUNING

This unit can store station frequencies (selected by tuning operation) by using preset station buttons. With this function, you can select any desired station by only pressing the corresponding preset station button. Up to 16 stations can be programmed.

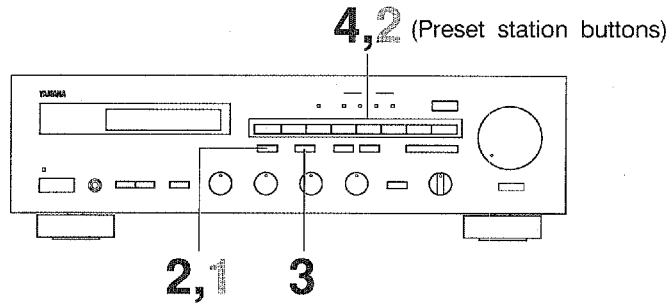

To program stations

- 1 Tune to a desired station.
(Refer to the previous page for tuning procedures.)
- 2 Select the range (P1-8 or P9-16) of the preset station buttons while watching the display.
- 3

Flashes on and off for about 5 seconds.
- 4

Shows the displayed station has been programmed to P1.

* In the same way, program other stations to P2, P3 ... P8.
 * To program stations to P9, P10 ... P16, in step 2, "P9-P16" should be illuminated in the display.

To recall a preset station

- 1 Select the range of the preset station buttons.
- 2

Select the desired one.

Notes

- In step 4, press a preset station button before "MEMORY" goes off from the display.
- A new setting can be programmed in place of the former one.
- For presets, the setting of the reception mode (stereo or monaural) is stored along with the station frequency.

Memory back-up

The memory back-up circuit prevents the programmed data from being lost even if the power is cut (for timer use or due to temporary power failure). If, however, the power is cut (because of disconnection of the AC power plug etc.) for more than two weeks, the memory may be erased. If so, it can be re-programmed by simply following the PRESET TUNING steps.

REMOTE-CONTROL TRANSMITTER

The remote-control transmitter provided with this unit is designed to control all the most commonly used functions of the unit. If the CD player, turntable, equalizer, and tape deck connected to this unit are YAMAHA components designed for remote control compatibility (components with an **RS** mark), then this remote-control transmitter will also control various functions of each component. Please consult YAMAHA dealer for information on which components are compatible with the remote-control transmitter.

Key Functions

For Receiver Control

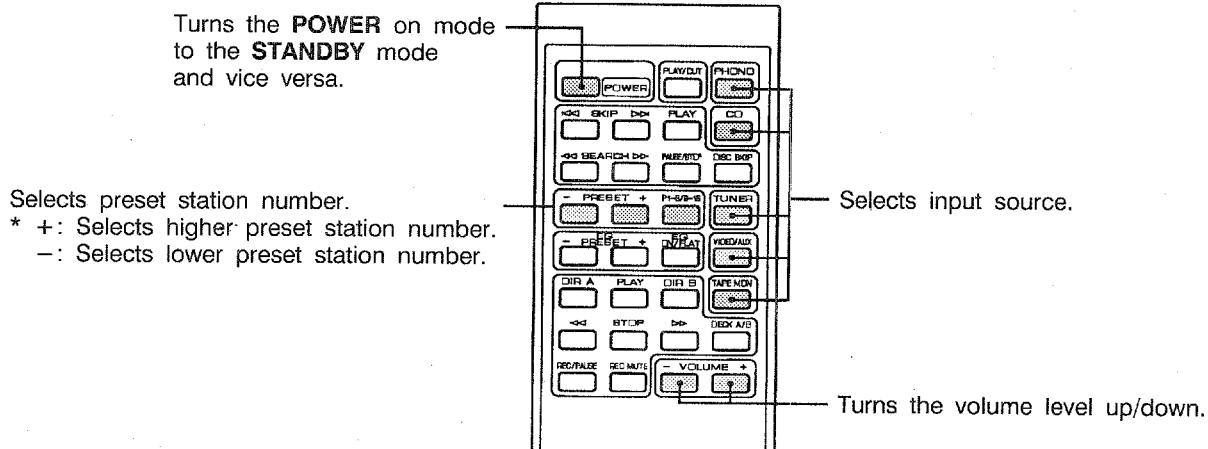

For Other Component Control

Identify the remote-control transmitter keys with your component's keys. On each key function, refer to the corresponding instruction on your component's manual.

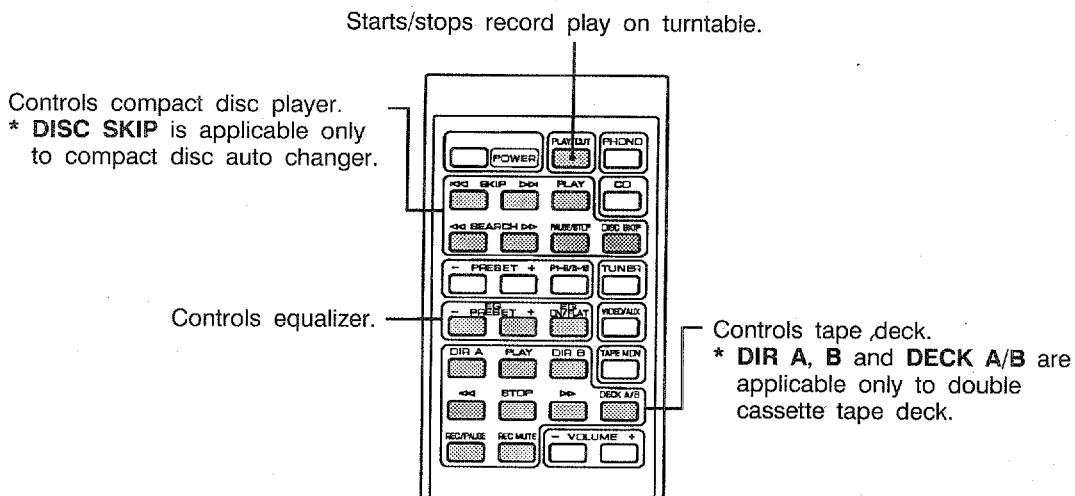

STANDBY Mode

While the power is on, pressing the **POWER** key on the remote control transmitter switches the unit to the **STANDBY** mode. (In this mode, the indicator is half illuminated.)

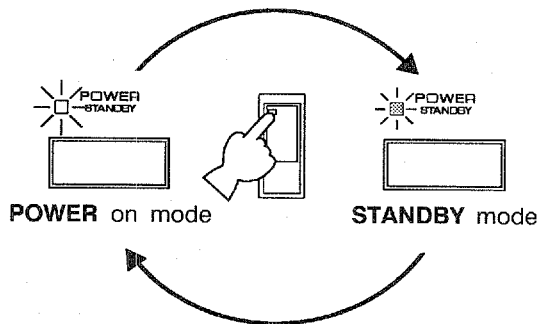

NOTES ABOUT THE REMOTE CONTROL TRANSMITTER

Battery installation

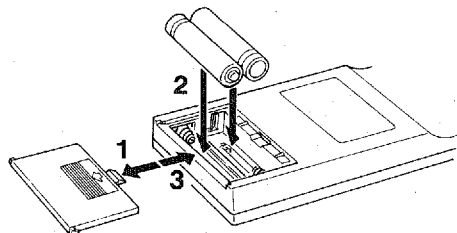

Battery replacement

If the remote-control transmitter must be used closer to the main unit, the batteries are weak. Replace both batteries with new ones.

Notes:

- Use only "AAA" (R03) batteries for replacement.
- Be sure the polarities are correct. (See the illustration inside the battery compartment.)
- Remove the batteries if the remote-control transmitter will not be used for an extended period of time.
- If batteries leak, immediately dispose of them. Avoid touching the leaked material or letting it come in contact with clothing, etc. Clean the battery compartment thoroughly before installing new batteries.

Remote-control transmitter operation range

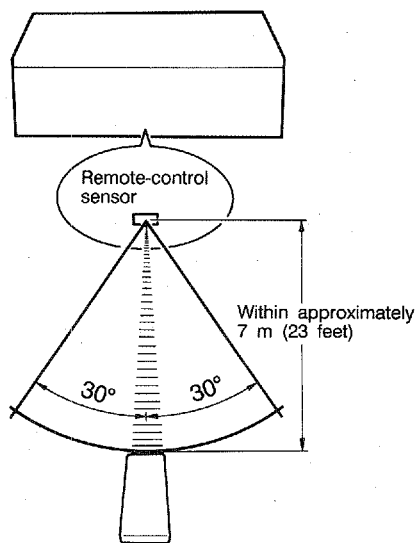

There should be no large obstacles between the remote-control transmitter and the main unit.

TROUBLESHOOTING

If the unit fails to operate normally, check the following points to determine whether the fault can be corrected by the simple measures suggested. If it cannot be corrected, or if the fault is not listed in the SYMPTOM column, disconnect the power cord and contact your dealer or service center for help.

	SYMPTOM	CAUSE	REMEDY
Amplifier	The receiver fails to turn on when the POWER switch is pressed.	Power cord is not plugged in or is not completely inserted.	Firmly plug in the power cord.
	No sound.	Incorrect output cord connections.	Connect cord properly. If the problem persists, the cables may be defective.
		Incorrect input selection.	Set the receiver controls to the correct input selection.
FM	Sound "hums".	Incorrect cord connections.	Firmly connect the audio plugs. If the problem persists, the cord may be defective.
	FM stereo reception is noisy.	Because of the characteristics of FM stereo broadcasts, this is limited to cases where the transmitter is far away or the antenna input is poor.	Check the antenna connections. Try using a multiple element FM antenna.
	There is distortion and clear reception cannot be obtained even with a good FM antenna.	There is multipath interference.	Adjust antenna placement to eliminate multipath interference.
AM	A desired station cannot be tuned in with Auto tuning.	The station is too weak.	Use Manual tuning mode. Use high quality directional FM antenna.
	A desired station cannot be tuned in with Auto tuning.	Weak signal or loose antenna connections.	Tighten the AM loop antenna connections and rotate it for best reception. Use Manual tuning mode.
	There are continuous crackling and hissing noises.	These noises result from lightning, fluorescent lamps, motors, thermostats and other electrical equipment.	Use an outdoor antenna and a ground wire. This will help some what but it is difficult to eliminate all noise.
	There are buzzing and whining noises (especially in the evening).	A television set is being used nearby.	Move the television away.

SPECIFICATIONS

AUDIO SECTION

Minimum RMS Output Power per Channel	
8 ohms, 20 Hz to 20 kHz, 0.04% THD	
[U.S.A., Canada and General models]	45 W
[Australia, Europe and U.K. models]	40 W
6 ohms, 20 Hz to 20 kHz, 0.06% THD	
[U.S.A., Canada and General models]	48 W
4 ohms, 20 Hz to 20 kHz, 0.1% THD	
[Canada model only]	50 W
Dynamic Power per Channel (IHF)	
8/6/4/2 ohms	
[U.S.A., Canada and General models]	78/90/108/112 W
[Australia, Europe and U.K. models]	75/84/100/103 W
DIN Standard Output Power per Channel	
4 ohms, 1 kHz, 0.7% THD	
[Europe model only]	55 W
IEC Power (1 kHz, 0.04% THD, 8 ohms)	
[Europe model only]	50 W
Power Band Width	
8 ohms, 20 W, 0.1% THD	10 Hz to 40 kHz
Damping Factor	
8 ohms, 1 kHz	50 or more
Input Sensitivity/Impedance	
PHONO	2.5 mV/47 k-ohms
CD/TAPE/VIDEO/AUX	150 mV/50 k-ohms
Maximum Input Signal Level (1 kHz, 0.01% THD)	
PHONO	110 mV
Output Level/Impedance	
REC OUT	150 mV/550 ohms
Headphone Jack Rated Output/Impedance	
	0.6 V/ 8 ohms
Frequency Response (20 Hz to 20 kHz)	
CD/TAPE/VIDEO/AUX	±0.5 dB
RIAA Equalization Deviation (20 Hz to 20 kHz)	
PHONO	±0.5 dB
Total Harmonic Distortion (20 Hz to 20 kHz)	
PHONO to REC OUT (3 V)	0.01%
CD/TAPE/VIDEO/AUX to SP OUT (20 W/8 ohms)	0.02%
Intermodulation Distortion	
CD/TAPE/VIDEO/AUX (Rated Output/8 ohms)	0.04%
Signal-to-Noise Ratio (IHF-A Network)	
PHONO (5 mV Input Shorted)	
[U.S.A., Canada, U.K., Australia and General models]	87 dB
[Europe model only]	82 dB
CD/TAPE/VIDEO/AUX (Shorted)	103 dB
Residual Noise (IHF-A Network)	140 µV
Channel Separation (1 kHz, Vol. -30 dB)	
PHONO (Input Shorted)	55 dB
CD/TAPE/VIDEO/AUX	
(Input 5.1 k-ohms Terminated)	52 dB

Tone Control Characteristics

BASS : Boost/cut	±10 dB (50 Hz)
Turnover Frequency	350 Hz
TREBLE : Boost/cut	±10 dB (20 kHz)
Turnover Frequency	3.5 kHz
Filter Characteristics	
Bass Extension	60 Hz, 8 dB
Continuous Loudness Control	
	-40 dB (1 kHz)
	(Level related equalization)

FM SECTION

Tuning Range	
[U.S.A., Canada and General models]	87.5 to 107.9 MHz
[Australia, Europe, U.K. and General models]	87.5 to 108.0 MHz
50 dB Quieting Sensitivity (IHF, 75 ohms)	
[Except Europe model]	
Mono	1.55 µV (15.1 dBf)
Stereo	21 µV (37.7 dBf)
Usable Sensitivity (75 ohms)	
(30 dB S/N Quieting, 1 kHz, 100% mod.)	
[Except Europe model]	0.8 µV (9.3 dBf)
DIN, Mono (S/N 26 dB) [Europe model]	
DIN, Stereo (S/N 46 dB) [Europe model]	0.9 µV
	24 µV
Image Response Ratio	
[Except Europe model]	45 dB
[Europe model]	80 dB
IF Response Ratio	80 dB
Spurious Response Ratio	70 dB
AM Suppression Ratio	55 dB
Capture Ratio	1.5 dB
Alternate Channel Selectivity	
[Except Europe model]	85 dB
Selectivity (two signals, 40 kHz Dev.)	
[Europe model]	50 dB
Signal-to-Noise Ratio	
(IHF) Mono/Stereo	
[Except Europe model]	81/76 dB
(DIN-weighted, 40 kHz Dev.) Mono/Stereo	
[Europe model]	75/70 dB
Harmonic Distortion (1 kHz)	
Mono/Stereo	
[Except Europe model]	0.1/0.2%
Stereo (40 kHz Dev.)	
[Europe model]	0.2%
Frequency Response	
30 Hz to 13 kHz	0±0.5 dB
20 Hz to 15 kHz	0±1.5 dB
Stereo Separation (1 kHz)	
[Except Europe model]	50 dB
[Europe model (40 kHz Dev.)]	50 dB

AM SECTION

Tuning Range	
[U.S.A., Canada and General models]	530 to 1,710 kHz
[Australia, Europe, U.K. and General models]	531 to 1,611 kHz
Usable Sensitivity	100 µV/m
Selectivity	32 dB
Signal-to-Noise Ratio	50 dB
Image Response Ratio	40 dB
Spurious Response Ratio	50 dB
Harmonic Distortion (400 Hz)	0.3%

AUDIO SECTION

Output Level/Impedance	
FM (100% mod., 1 kHz)	
[Except Europe model]	500 mV/2.2 k-ohms
[Europe model (40 kHz Dev.)]	400 mV/6.8 k-ohms
AM (30% mod., 400 Hz)	
[Except Europe model]	150 mV/2.2 k-ohms
[Europe model (40 kHz Dev.)]	150 mV/6.8 k-ohms

GENERAL

Power Supply	
[U.S.A. and Canada models]	AC 120 V, 60 Hz
[Australia and U.K. models]	AC 240 V, 50 Hz
[Europe model]	AC 230 V, 50 Hz
[General model]	AC 110/120/220/240 V, 60/50 Hz
Power Consumption	
[U.S.A. model only]	180 W
[Canada model only]	200 W
[Australia, Europe, U.K. and General models]	160 W
AC Outlets	
[U.S.A., Canada and General models only]	Switched
	100 W max.
Dimensions (W x H x D)	
	435 x 131 x 292 mm
	(17-1/8" x 5-3/16" x 11-1/2")
Weight	5.7 kg (12 lbs. 9 oz.)
Accessories	AM loop antenna
	Indoor FM antenna
	Remote Control Transmitter
	Batteries

Specifications subject to change without notice.

YAMAHA ELECTRONICS CORPORATION, USA 6722 ORANGETHORPE AVE., BUENA PARK, CALIF. 90620, U.S.A.
 YAMAHA CANADA MUSIC LTD. 135 MILNER AVE., SCARBOROUGH, ONTARIO M1S 3R1, CANADA
 YAMAHA ELECTRONIK EUROPA G.m.b.H. SIEMENSSTR. 22-34, D-2084 BELLINGEN, BEI HAMBURG, F.R. OF GERMANY
 YAMAHA ELECTRONIQUE FRANCE S.A. 17 RUE DES CAMPANULES, LOGNES 77321 MARNE LA VALLÉE CEDEX 2, FRANCE
 YAMAHA ELECTRONICS (UK) LTD. YAMAHA HOUSE, 200 RICKMANSWORTH ROAD, WATFORD, HERTS WD1 7JS, ENGLAND
 YAMAHA SCANDINAVIA A.B. J A WETTERSPRENS GATA 1, BOX 30053, 400 43 VÄSTRA FRÖLUNDA, SWEDEN
 YAMAHA MUSIC AUSTRALIA PTY, LTD. 17-33 MARKET ST., SOUTH MELBOURNE, 3205 VIC., AUSTRALIA

YAMAHA
 YAMAHA CORPORATION

VJ91940-0 BWWB2, BB2 Printed in Japan