

YAMAHA

RX-596

Natural Sound Stereo Receiver

Récepteur stéréo "Son Naturel"

Thank you for selecting this YAMAHA stereo receiver.

Nous vous remercions d'avoir porté votre choix sur ce récepteur stéréo YAMAHA.

**OWNER'S MANUAL
MODE D'EMPLOI**

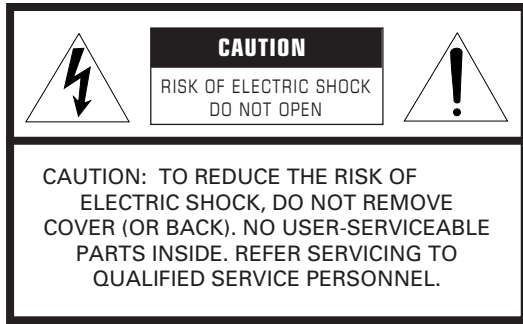

IMPORTANT
Please record the serial number of this unit in the space below.
Model:
Serial No.:

The serial number is located on the rear of the unit.
Retain this Owner's Manual in a safe place for future reference.

• Explanation of Graphical Symbols

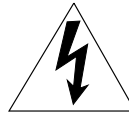

The lightning flash with arrowhead symbol, within an equilateral triangle, is intended to alert you to the presence of uninsulated "dangerous voltage" within the product's enclosure that may be of sufficient magnitude to constitute a risk of electric shock to persons.



The exclamation point within an equilateral triangle is intended to alert you to the presence of important operating and maintenance (servicing) instructions in the literature accompanying the appliance.

WARNING
TO REDUCE THE RISK OF FIRE OR ELECTRIC SHOCK, DO NOT EXPOSE THIS UNIT TO RAIN OR MOISTURE.

SAFETY INSTRUCTIONS

- 1 Read Instructions – All the safety and operating instructions should be read before the unit is operated.
- 2 Retain Instructions – The safety and operating instructions should be retained for future reference.
- 3 Heed Warnings – All warnings on the unit and in the operating instructions should be adhered to.
- 4 Follow Instructions – All operating and other instructions should be followed.
- 5 Water and Moisture – The unit should not be used near water – for example, near a bathtub, washbowl, kitchen sink, laundry tub, in a wet basement, or near a swimming pool, etc.
- 6 Carts and Stands – The unit should be used only with a cart or stand that is recommended by the manufacturer.
- 6A A unit and cart combination should be moved with care. Quick stops, excessive force, and uneven surfaces may cause the unit and cart combination to overturn. 
- 7 Wall or Ceiling Mounting – The unit should be mounted to a wall or ceiling only as recommended by the manufacturer.
- 8 Ventilation – The unit should be situated so that its location or position does not interfere with its proper ventilation. For example, the unit should not be situated on a bed, sofa, rug, or similar surface, that may block the ventilation openings; or placed in a built-in installation, such as a bookcase or cabinet that may impede the flow of air through the ventilation openings.
- 9 Heat – The unit should be situated away from heat sources such as radiators, stoves, or other appliances that produce heat.
- 10 Power Sources – The unit should be connected to a power supply only of the type described in the operating instructions or as marked on the unit.
- 11 Power-Cord Protection – Power-supply cords should be routed so that they are not likely to be walked on or pinched by items placed upon or against them, paying particular attention to cords at plugs, convenience receptacles, and the point where they exit from the unit.
- 12 Cleaning – The unit should be cleaned only as recommended by the manufacturer.
- 13 Nonuse Periods – The power cord of the unit should be unplugged from the outlet when left unused for a long period of time.
- 14 Object and Liquid Entry – Care should be taken so that objects do not fall into and liquids are not spilled into the inside of the unit.
- 15 Damage Requiring Service – The unit should be serviced by qualified service personnel when:
 - A. The power-supply cord or the plug has been damaged; or
 - B. Objects have fallen, or liquid has been spilled into the unit; or
 - C. The unit has been exposed to rain; or
 - D. The unit does not appear to operate normally or exhibits a marked change in performance; or
 - E. The unit has been dropped, or the cabinet damaged.
- 16 Servicing – The user should not attempt to service the unit beyond those means described in the operating instructions. All other servicing should be referred to qualified service personnel.
- 17 Power Lines – An outdoor antenna should be located away from power lines.
- 18 Grounding or Polarization – Precautions should be taken so that the grounding or polarization is not defeated.

19 For US customers only:

Outdoor Antenna Grounding – If an outside antenna is connected to this unit, be sure the antenna system is grounded so as to provide some protection against voltage surges and built-up static charges. Article 810 of the National Electrical Code, ANSI/NFPA 70, provides information with regard to proper grounding of the mast and supporting structure, grounding of the lead-in wire to an antenna discharge unit, size of grounding conductors, location of antenna discharge unit, connection to grounding electrodes, and requirements for the grounding electrode.

Note to CATV system installer:

This reminder is provided to call the CATV system installer's attention to Article 820-40 of the NEC that provides guidelines for proper grounding and, in particular, specifies that the cable ground shall be connected to the grounding system of the building, as close to the point of cable entry as practical.

SPECIAL NOTES FOR FCC COMPOSITE DEVICE (for US customers only)

This device is a composite system. The digital device component may not cause harmful interference.

EXAMPLE OF ANTENNA GROUNDING

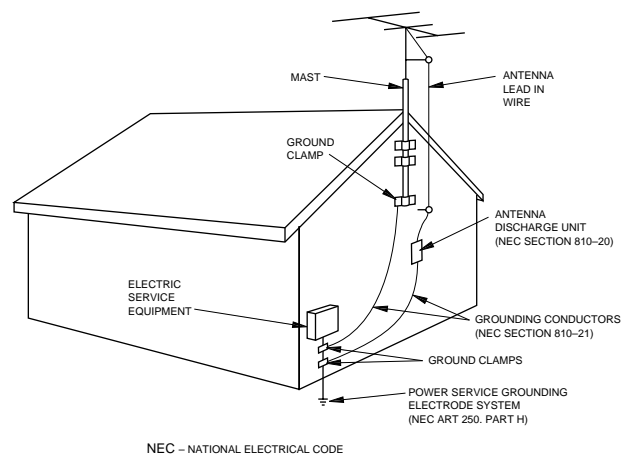
**FCC INFORMATION (for US customers only)****1. IMPORTANT NOTICE : DO NOT MODIFY THIS UNIT!**

This product, when installed as indicated in the instructions contained in this manual, meets FCC requirements. Modifications not expressly approved by Yamaha may void your authority, granted by the FCC, to use the product.

2. IMPORTANT : When connecting this product to accessories and/or another product use only high quality shielded cables. Cable/s supplied with this product MUST be used. Follow all installation instructions. Failure to follow instructions could void your FCC authorization to use this product in the USA.**3. NOTE :** This product has been tested and found to comply with the requirements listed in FCC Regulations, Part 15 for Class "B" digital devices. Compliance with these requirements provides a reasonable level of assurance that your use of this product in a residential environment will not result in harmful interference with other electronic devices.

This equipment generates/uses radio frequencies and, if not installed and used according to the instructions found in the users manual, may cause interference harmful to the operation of other electronic devices.

Compliance with FCC regulations does not guarantee that interference will not occur in all installations. If this product is found to be the source of interference, which can be determined by turning the unit "OFF" and "ON", please try to eliminate the problem by using one of the following measures:

Relocate either this product or the device that is being affected by the interference.

Utilize power outlets that are on different branch (circuit breaker or fuse) circuits or install AC line filter/s.

In the case of radio or TV interference, relocate/reorient the antenna. If the antenna lead-in is 300 ohm ribbon lead, change the lead-in to coaxial type cable.

If these corrective measures do not produce satisfactory results, please contact the local retailer authorized to distribute this type of product. If you can not locate the appropriate retailer, please contact Yamaha Electronics Corp., U.S.A. 6660 Orangethorpe Ave, Buena Park, CA 90620.

The above statements apply ONLY to those products distributed by Yamaha Corporation of America or its subsidiaries.

We Want You Listening For A Lifetime (for US customers only)

YAMAHA and the Electronic Industries Association's Consumer Electronics Group want you to get the most out of your equipment by playing it at a safe level. One that lets the sound come through loud and clear without annoying blaring or distortion – and, most importantly, without affecting your sensitive hearing.

Since hearing damage from loud sounds is often undetectable until it is too late, YAMAHA and the Electronic Industries Association's Consumer Electronics Group recommend you to avoid prolonged exposure from excessive volume levels.



FEATURES

- **80W + 80W (8Ω) RMS Output Power, 0.025% THD, 20–20,000 Hz**
- **90W + 90W (6Ω) RMS Output Power, 0.05% THD, 20–20,000 Hz**
- **High Dynamic Power, Low Impedance Drive Capability**
- **Continuously Variable LOUDNESS Control**
- **CD DIRECT AMP Switch to Reproduce the Purest CD Sound**
- **PURE DIRECT Switch to Reproduce the Purest Source Sound**
- **40-Station Random Access Preset Tuning**
- **Automatic Preset Tuning**
- **Preset Station Shifting Capability (Preset Editing)**
- **IF Count Direct PLL Synthesizer Tuning System**
- **Video Signal Input/Output Capability**
- **SLEEP Timer**
- **Remote Control Capability**

CONTENTS

SAFETY INSTRUCTIONS.....Inside the Front Cover	CONTROLS AND THEIR FUNCTIONS.....9
FEATURES2	BASIC OPERATIONS13
SUPPLIED ACCESSORIES3	TUNING OPERATIONS16
CAUTION4	PRESET TUNING17
NOTES ABOUT THE REMOTE CONTROL TRANSMITTER.....5	TROUBLESHOOTING20
CONNECTIONS.....6	SPECIFICATIONS.....21

CAUTION : READ THIS BEFORE OPERATING YOUR UNIT.

1. To assure the finest performance, please read this manual carefully. Keep it in a safe place for future reference.
2. Install this unit in a cool, dry, clean place – away from windows, heat sources, sources of excessive vibration, dust, moisture and cold. Avoid sources of humming (transformers, motors). To prevent fire or electrical shock, do not expose the unit to rain or water.
3. Never open the cabinet. If something drops into the set, contact your dealer.
4. Do not use force on switches, controls or connection wires. When moving the unit, first disconnect the power plug and the wires connected to other equipment. Never pull the wires themselves.
5. The openings on the cabinet assure proper ventilation of the unit. If these openings are obstructed, the temperature inside the cabinet will rise rapidly. Therefore, avoid placing objects against these openings, and install the unit in well-ventilated condition. Be sure to allow a space of at least 10 cm behind, 10 cm on the both sides and 20 cm above the top panel of the unit. Otherwise it may not only damage the unit, but also cause fire.
6. Always set the VOLUME control to “– ∞” before starting the audio source play. Increase the volume gradually to an appropriate level after playback has been started.
7. Do not attempt to clean the unit with chemical solvents; this might damage the finish. Use a clean, dry cloth.
8. Be sure to read the “TROUBLESHOOTING” section regarding common operating errors before concluding that the unit is faulty.
9. When not planning to use this unit for long periods of time (ie., vacation, etc.), disconnect the AC power plug from the wall outlet.
10. To prevent lightning damage, disconnect the AC power plug and antenna cable when there is an electrical storm.
11. Grounding or polarization – Precautions should be taken so that the grounding or polarization of an appliance is not defeated.
12. Do not connect audio equipment to the AC outlet on the rear panel if the equipment requires more power than the outlet is rated to provide.

This unit is not disconnected from the AC power source as long as it is connected to the wall outlet, even if this unit itself is turned off. This state is called the standby mode. In this state, this unit is designed to consume a very small quantity of power.

IMPORTANT

Please record the serial number of this unit in the space below.

Model:

Serial No.:

The serial number is located on the rear of the unit. Retain this Owner's Manual in a safe place for future reference.

WARNING

TO REDUCE THE RISK OF FIRE OR ELECTRIC SHOCK, DO NOT EXPOSE THIS UNIT TO RAIN OR MOISTURE.

FOR CANADIAN CUSTOMERS

TO PREVENT ELECTRIC SHOCK, MATCH WIDE BLADE OF PLUG TO WIDE SLOT AND FULLY INSERT.

THIS CLASS B DIGITAL APPARATUS MEETS ALL REQUIREMENTS OF THE CANADIAN INTERFERENCE-CAUSING EQUIPMENT REGULATIONS.

NOTES ABOUT THE REMOTE CONTROL TRANSMITTER

Battery installation

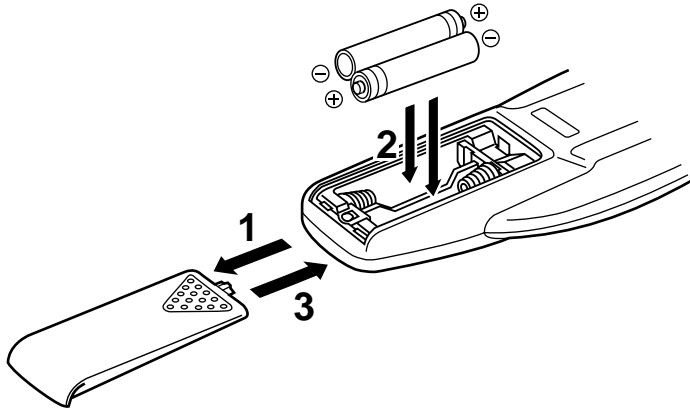

Remote control transmitter operation range

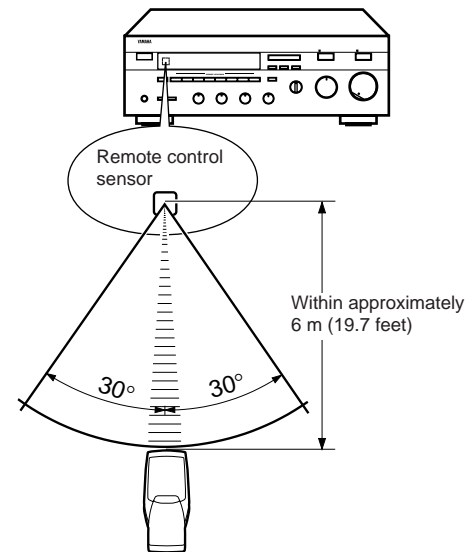

Battery replacement

If you find that the remote control transmitter must be used closer to the main unit, the batteries are weak. Replace both batteries with new ones.

Notes

- Use only AA, R6, UM-3 batteries for replacement.
- Be sure the polarities are correct. (See the illustration inside the battery compartment.)
- Remove the batteries if the remote control transmitter will not be used for an extended period of time.
- If batteries leak, dispose of them immediately. Avoid touching the leaked material or letting it come in contact with clothing, etc. Clean the battery compartment thoroughly before installing new batteries.

Notes

- There should be no large obstacles between the remote control transmitter and the main unit.
- If the remote control sensor is directly illuminated by strong lighting (especially an inverter type of fluorescent lamp etc.), it might cause the remote control transmitter not to work correctly. In this case, reposition the main unit to avoid direct lighting.

CONNECTIONS

Never plug in this unit and other components until all connections are completed.

CONNECTIONS WITH OTHER COMPONENTS

When making connections between this unit and other components, be sure all connections are made correctly, that is to say L (left) to L, R (right) to R, "+" to "+" and "-" to "-". Also, refer to the owner's manual for each component to be connected to this unit.

* If you have YAMAHA components numbered as 1, 3, 4, etc. on the rear panel, connections can be made easily only by connecting the output (or input) terminals of each component to the same-numbered terminals of this unit.

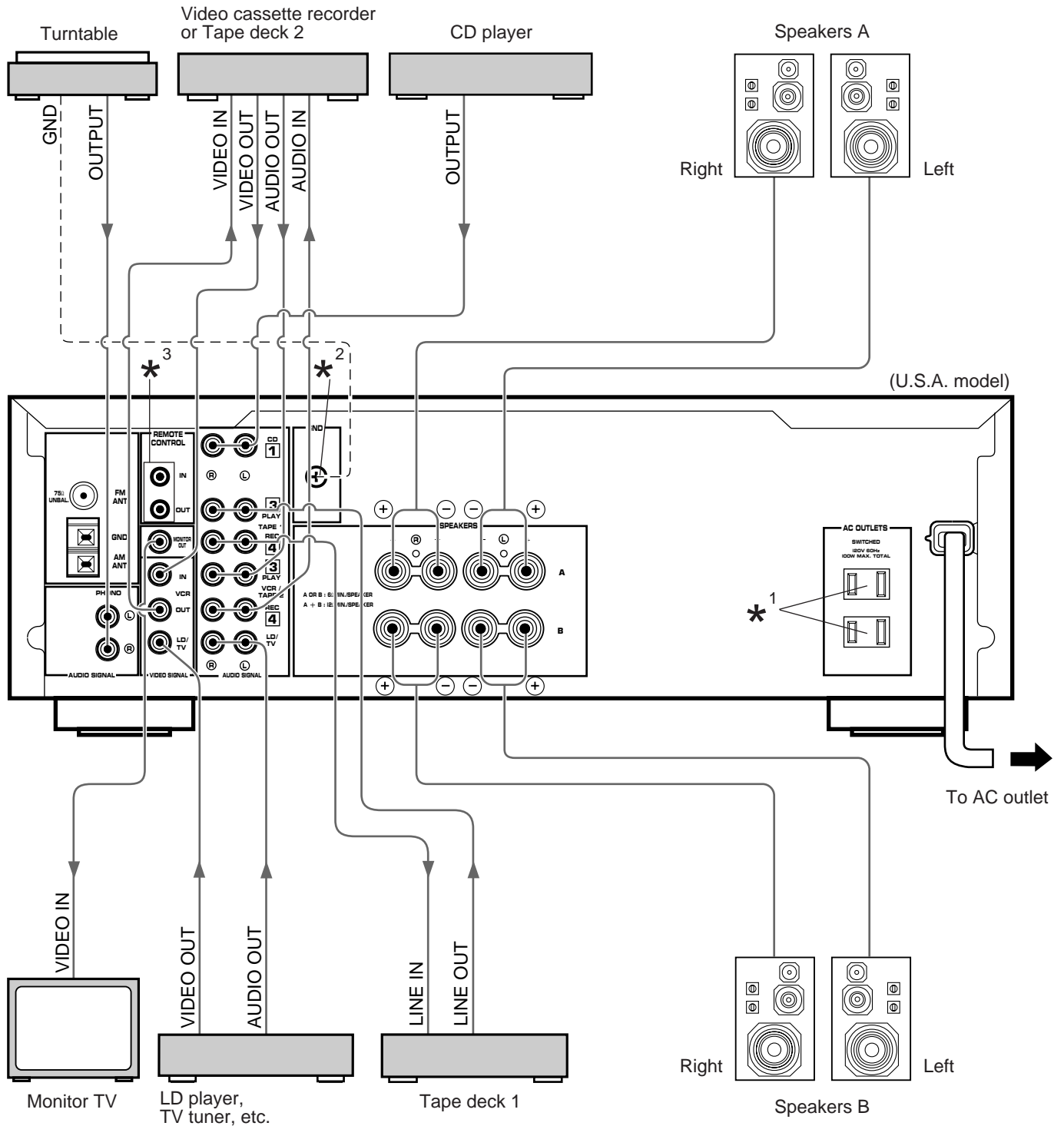

*¹, *², *³ : See the next page.

* If a tape deck is connected to the VCR/TAPE 2 (AUDIO SIGNAL) terminals, there is no connection to the VCR (VIDEO SIGNAL) terminals.

CONNECTING SPEAKERS

Connect the **SPEAKERS** terminals to your speakers with wire of the proper gauge (cut as short as possible). If the connections are faulty, no sound will be heard from the speakers. Make sure that the polarity of the speaker wires is correct, that is, + and – markings are observed. If these wires are reversed, the sound will be unnatural and will lack bass.

Do not let the bare speaker wires touch each other or the metal parts of this unit as this could damage this unit and/or speakers.

How to Connect:

Red: positive (+)
Black: negative (–)

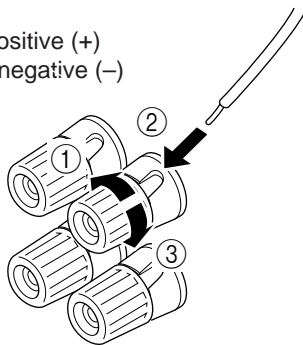

- ① Unscrew the knob.
- ② Insert the bare wire.
[Remove approx. 5mm (1/4") insulation from the speaker wires.]
- ③ Tighten the knob and secure the wire.

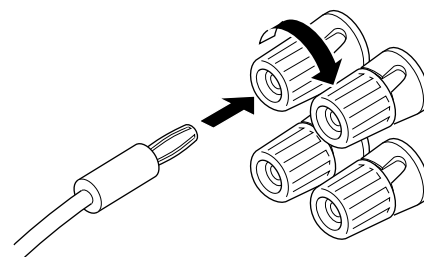

Notes

- One or two speaker systems can be connected to this unit. If you connect only one speaker system, connect it to either the **SPEAKERS A** or **B** terminals.
- Use speakers with the specified impedance shown on the rear of this unit.
- Banana Plug connections are also possible. Simply insert the Banana Plug connector into the corresponding terminal.

*¹ AC OUTLET(S) (SWITCHED)

(U.S.A., Canada, and General models)

..... 2 SWITCHED OUTLETS
(Australia model) 1 SWITCHED OUTLET

Use these to connect the power cords from your components to this unit.

The power to the **SWITCHED** outlets is controlled by this unit's **STANDBY/ON** switch or the provided remote control transmitter's **POWER ON/OFF** keys. These outlets will supply power to any component whenever this unit is turned on. The maximum power (total power consumption of components) that can be connected to the **SWITCHED AC OUTLET(S)** is 100 watts.

*² GND terminal (For turntable use)

Connecting the ground wire of the turntable to the **GND** terminal will normally minimize hum, but in some cases better results may be obtained with the ground wire disconnected.

*³ For Custom Installer

For U.S.A., Canada and Australia models only REMOTE CONTROL (IN, OUT) terminals

These terminals are used for custom installation system. When this unit is connected to the components for custom installation system, you can operate this unit with the system remote control.

Connect the **REMOTE CONTROL IN** terminal of this unit to the output terminal of the central controller for custom installation system.

By connecting the **REMOTE CONTROL OUT** terminal of this unit to the **REMOTE CONTROL IN** terminal of the other component, you can also operate the component with the system remote control. In this way, up to 6 components can be connected in series.

ANTENNA CONNECTIONS

- Each antenna should be connected to the designated terminal(s) correctly, referring to the following diagram.
- Both AM and FM indoor antennas are supplied to this unit. In general, these antennas will provide sufficient signal strength. Nevertheless, a properly installed outdoor antenna will give clearer reception than an indoor one. If you experience poor reception quality, an outdoor antenna may result in improvement.

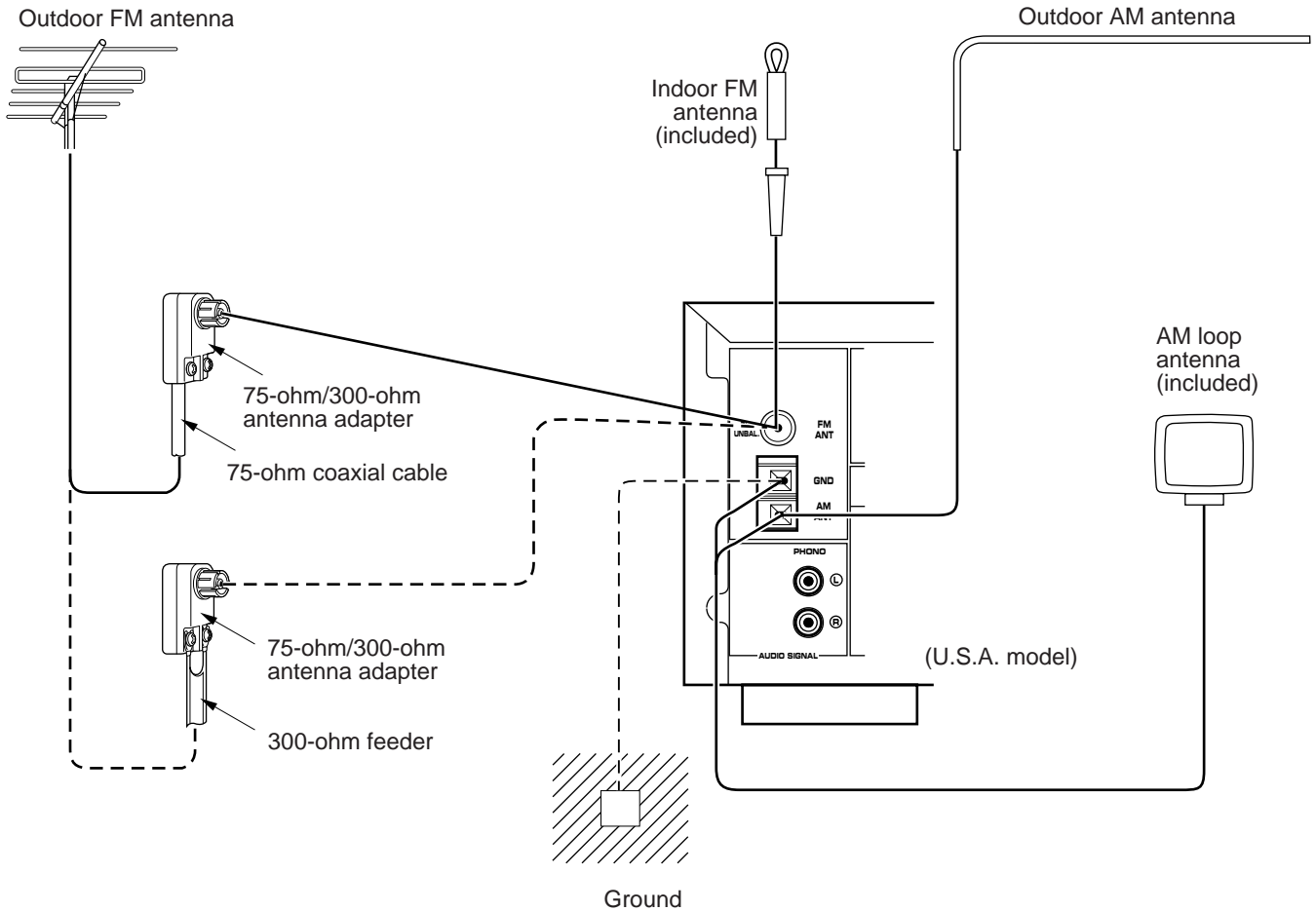

Connecting the AM loop antenna

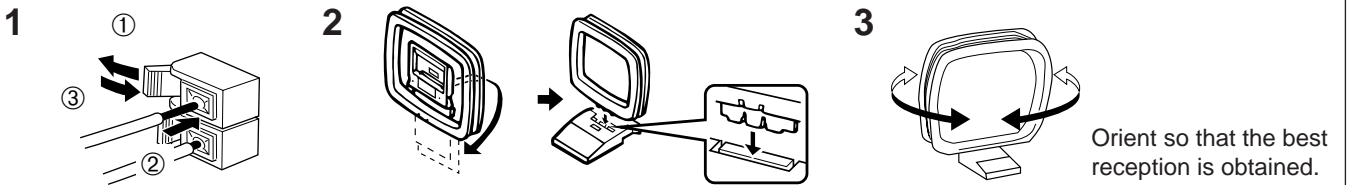

- * The AM loop antenna should be placed apart from the main unit. The antenna may be hung on a wall.
- * The AM loop antenna should be kept connected, even if an outdoor AM antenna is connected to this unit.

GND terminal

For maximum safety and minimum interference, connect the **GND** terminal to a good earth ground, which is a metal stake driven into moist earth.

Notes

- When connecting the indoor FM antenna, insert its connector into the **FM ANT** terminal firmly.
- If you need an outdoor FM antenna to improve FM reception quality, either 300-ohm feeder or coaxial cable may be used. In locations troubled by electrical interference, a coaxial cable is preferable.

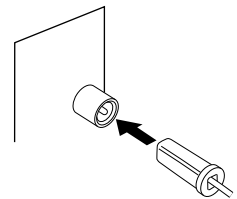

CONTROLS AND THEIR FUNCTIONS

FRONT PANEL

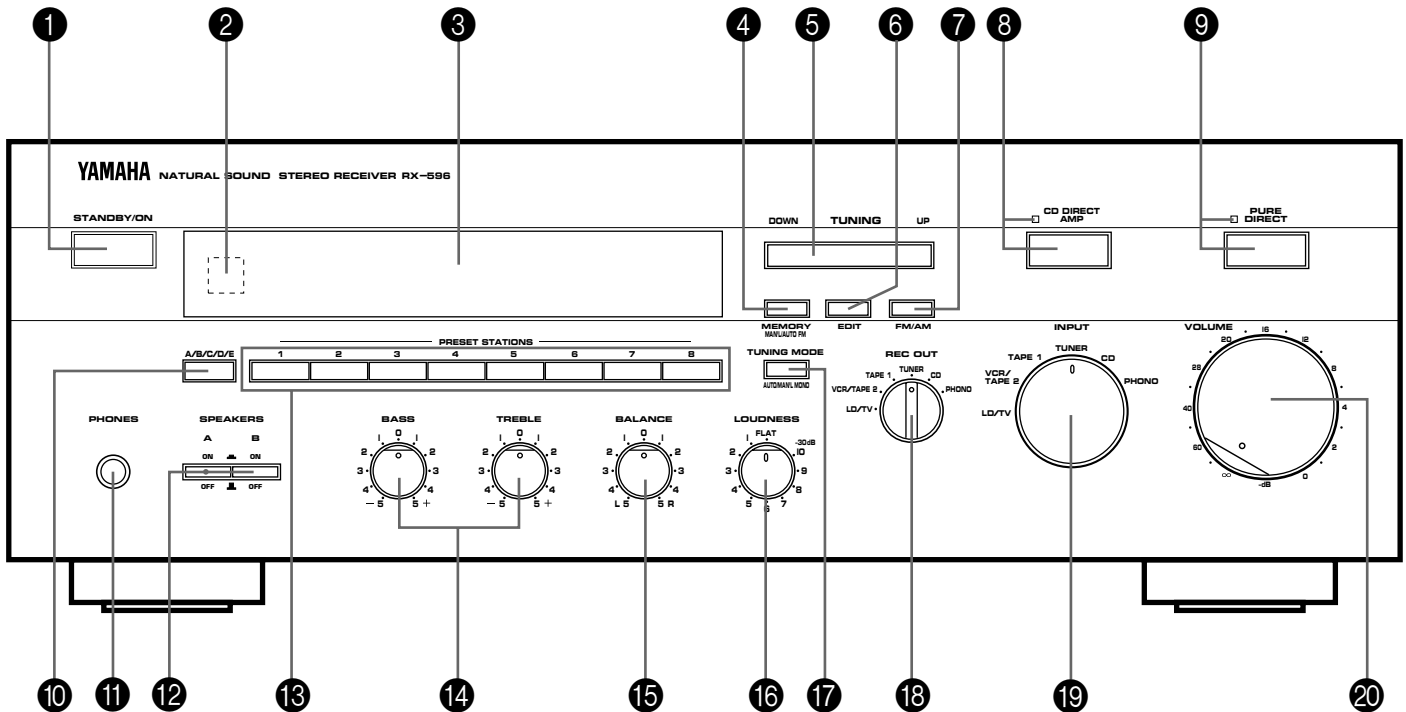

1 STANDBY/ON switch

Press this switch to turn on the power to this unit. Press it again to turn this unit into the standby mode.

Standby mode

In this state, this unit consumes a very small quantity of power to receive infrared-signals from the remote control transmitter.

2 Remote control sensor

Receives signals from the remote control transmitter.

3 Display panel

Shows various information. (For details, refer to page 11.)

4 MEMORY (MAN'L/AUTO FM) button

When this button is pressed, the "MEMORY" indicator flashes for about 5 seconds. While the indicator is flashing, select a desired preset station number by pressing the corresponding preset station number selector button to enter the displayed station into the memory.

When this button is held down for more than 3 seconds, the automatic preset tuning begins. (For details, refer to page 18.)

5 TUNING DOWN/UP button

Used for tuning. Press the "UP" side to tune in to higher frequencies, and press the "DOWN" side to tune in to lower frequencies.

6 EDIT button

This button is used to exchange the places of two preset stations with each other.

7 FM/AM button

Press this button to switch the reception band to FM or AM.

8 CD DIRECT AMP switch and indicator

Press this switch so that the indicator lights up to listen to a CD source in the purest sound. (Refer to page 15 for details.)

9 PURE DIRECT switch and indicator

Press this switch so that the indicator lights up to listen to an audio source in the purest sound. (Refer to page 15 for details.)

10 A/B/C/D/E button

Press this button to select a desired group (A–E) of preset stations.

11 PHONES jack

When you listen with headphones, connect the headphones to the **PHONES** jack.

When listening with headphones privately, set both the **SPEAKERS A** and **B** switches to the **OFF** position.

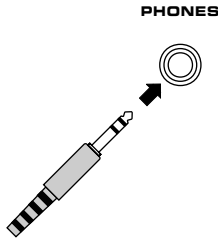

12 SPEAKERS switches

Set the switch **A** or **B** (or both **A** and **B**) for the speaker system (connected to this unit) you will use to the **ON** position. Set the switch for the speaker system you will not use to the **OFF** position.

13 PRESET STATIONS buttons

Select a preset station number (1 to 8).

14 Tone controls

BASS

Used to increase or decrease the low frequency response. The 0 position produces flat response.

TREBLE

Used to increase or decrease the high frequency response. The 0 position produces flat response.

15 BALANCE control

Adjusts the balance of the output volume to the left and right speakers to compensate for sound imbalance caused by speaker location or listening room conditions.

16 Continuously variable LOUDNESS control

Used to compensate for the human ears' loss of sensitivity to high and low-frequency ranges at low volume.

17 TUNING MODE (AUTO/MAN'L MONO) button

Press this button to switch the tuning mode to automatic or manual. To select the automatic tuning mode, press this button so that the "AUTO TUNING" indicator lights up on the display. To select the manual tuning mode, press this button so that the "AUTO TUNING" indicator goes off.

18 REC OUT selector

Used to select an input source and supply that source directly to the REC output terminals on the rear panel, independently of the setting of the **INPUT** selector. This function allows you to record the selected source while listening to another source.

19 INPUT selector

Selects the input source that you want to listen to (and watch).

20 VOLUME control

Used to raise or lower the volume level.

DISPLAY PANEL

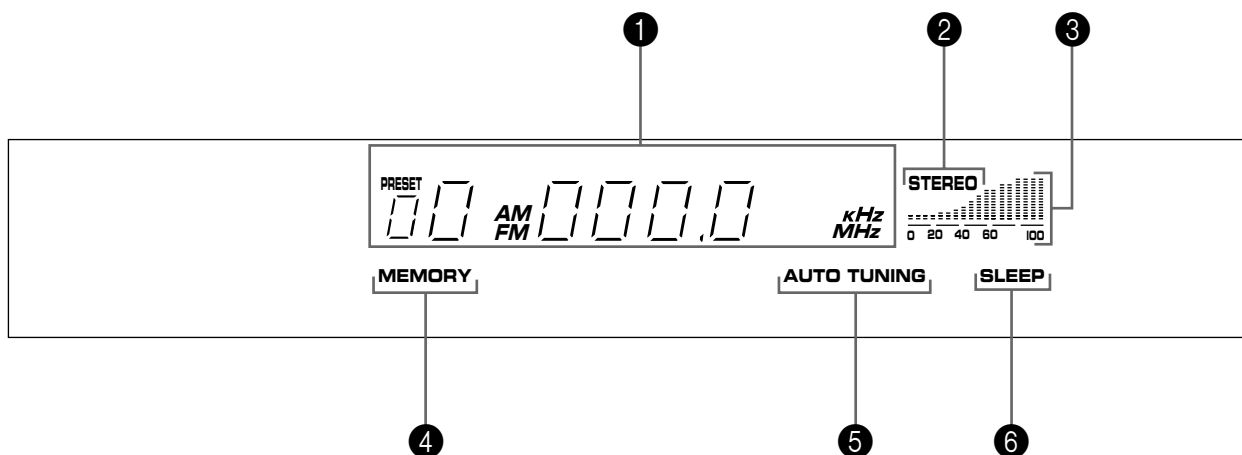

1 Multi-information display

Displays various information, for example station frequency, preset station number and name of selected input source.

2 STEREO indicator

Lights up when an FM stereo broadcast with sufficient signal strength is received.

3 Signal-level meter

Indicates the signal level of the received station. If multipath interference is detected, the indication decreases.

4 MEMORY indicator

When the **MEMORY** button is pressed, this indicator flashes for about 5 seconds. While this indicator is flashing, the displayed station can be programmed to the memory by using the **A/B/C/D/E** button and the **PRESET STATIONS** buttons.

5 AUTO TUNING indicator

Lights up when this unit is in the automatic tuning mode.

6 SLEEP indicator

Lights up while the built-in SLEEP timer is functioning.

REMOTE CONTROL TRANSMITTER

The remote control transmitter provided with this unit is designed to control all the most commonly used functions of this unit. If the CD player and tape deck connected to this unit are YAMAHA components designed for remote control compatibility, this remote control transmitter will also control various functions of each component.

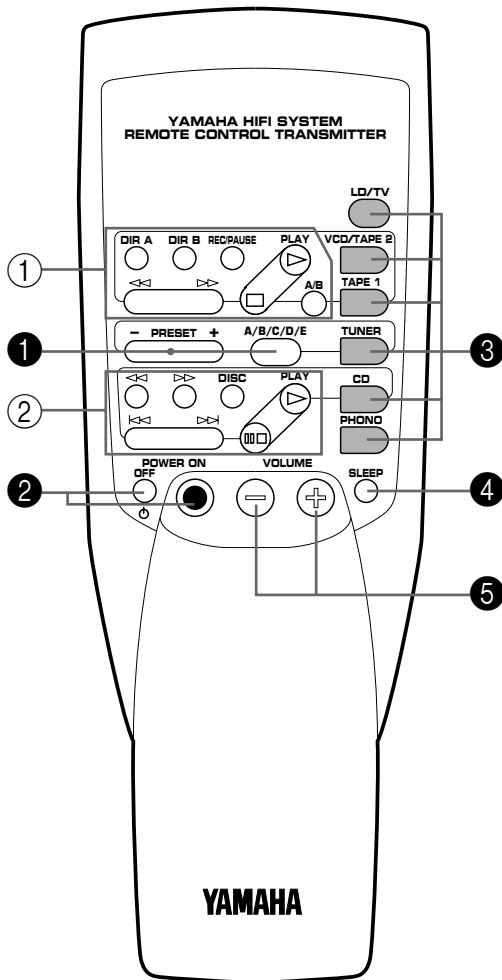

For Control of This Unit

① Tuner keys

Control tuner.

+: Selects higher preset station number.

-: Selects lower preset station number.

A/B/C/D/E: Selects the group (A – E) of preset station numbers.

② POWER ON and OFF keys

Pressing the **POWER ON** key turns the power to this unit on and pressing the **OFF** key turns this unit into the standby mode.

③ Input selector keys

Select input source.

④ SLEEP timer key

This unit is automatically turned into the standby mode one hour after this key is pressed (so that SLEEP indicator lights up).

⑤ VOLUME +/- keys

Turn the volume level up/down.

For Other Component Control

Identify the remote control transmitter keys with your component's keys. If these keys are identical, their functions will be the same. For each key function, refer to the corresponding instruction in your component's manual.

① Tape deck keys

Control tape deck.

* **DIR A, B** and **A/B** are applicable only to double cassette tape deck.

* For a single cassette deck with automatic reverse function, pressing **DIR A** will reverse the direction of tape running.

② CD player keys

Control compact disc player.

* **DISC** is applicable only to compact disc changer.

From page 13 to 19, this manual describes how to operate this unit mainly by using the front panel control parts. To operate this unit on the remote control transmitter, use the corresponding keys on the remote control transmitter.

BASIC OPERATIONS

TO PLAY A SOURCE

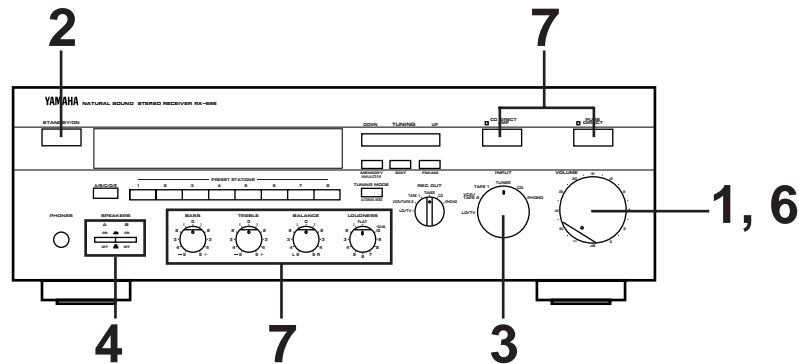

1

Set to the "∞" position.

2 Turn the power on.

3 Select the desired input source by using the **INPUT** selector.
(For video sources, turn the TV/monitor ON.)

- * The name of the selected input source position will appear on the display. (For "TUNER", the tuning mode will appear on the display.)
- * Note that selecting each input source position selects the source which is connected to the corresponding input terminals on the rear panel.

4 Select the speakers to be used.

* If you use two speaker systems, press both the A and B switches.

5 Play the source. (For detailed information on the tuning operation, refer to page 16.)

6

Adjust to the desired output level.

7 If desired, adjust the **BASS, TREBLE, BALANCE** and **LOUDNESS** controls, etc. (Refer to page 15.)

When you finish using this unit
Press the **STANDBY/ON** switch on the front panel again or the **POWER OFF** key on the remote control transmitter to turn this unit into the standby mode.

TO RECORD A SOURCE TO TAPE (OR MD)

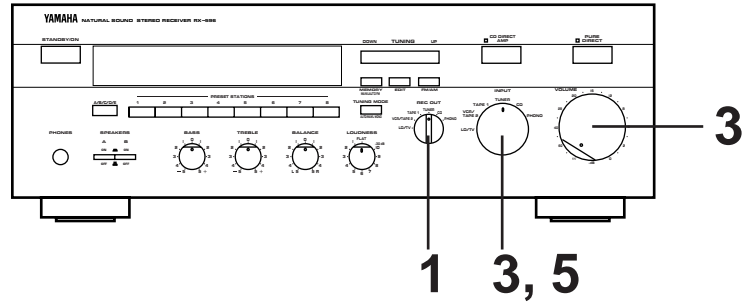

1 Select the source you want to record.

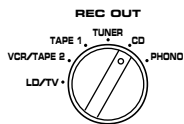

2 Play the source.

3 Confirm the source by selecting it with the **INPUT** selector and turning up the **VOLUME** control.

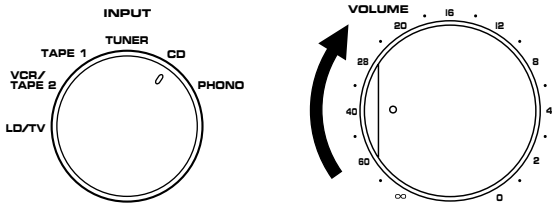

4 Begin recording on the tape deck (or MD recorder etc.) or VCR connected to this unit.

5 To monitor the sound (and/or picture) to be recorded, select the tape deck (or VCR) being used for recording with the **INPUT** selector.

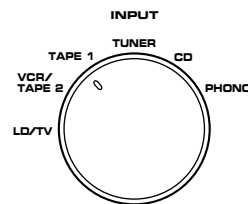

Notes

- If you want to enjoy another source while recording, select it with the **INPUT** selector.
- **VOLUME, BASS, TREBLE, BALANCE, LOUDNESS** controls, **CD DIRECT AMP** switch and **PURE DIRECT** switch settings have no effect on the material being recorded.

Adjusting the BALANCE control

Adjust the balance of the output volume to the left and right speakers to compensate for sound imbalance caused from speaker location or listening room conditions.



Adjusting the BASS and TREBLE controls

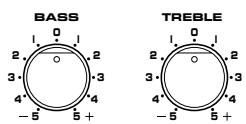

BASS : Turn this clockwise to increase (or counter-clockwise to decrease) the low frequency response.

TREBLE : Turn this clockwise to increase (or counter-clockwise to decrease) the high frequency response.

Using the CD DIRECT AMP switch

You can enjoy the purest possible CD sound from your CD player by setting this switch so that the indicator illuminates. By doing so, CD's input signals are sent to the built-in special amplifier for CD directly bypassing the **INPUT** selector, **BASS**, **TREBLE**, **BALANCE** and **LOUDNESS** controls, and then sent to the power amplifier. This signal routing reproduces the purest CD sound eliminating any alterations to the CD signals.

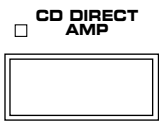

Note
If both **CD DIRECT AMP** and **PURE DIRECT** switches are on, only the **CD DIRECT AMP** switch will function.

Selecting the SPEAKER system

Because one or two speaker systems can be connected to this unit, the **SPEAKERS** switches allow you to select speaker system **A** or **B**, or both at once.

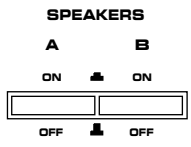

Adjusting the continuously variable LOUDNESS control

This control provides compensation for the human ears' loss of sensitivity to high and low-frequency ranges at low volume. This control is adjustable to retain full tonal range at any volume level.

1 Set to the "FLAT" position.

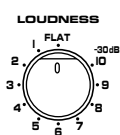

2 Set to the loudest listening level that you would listen in.

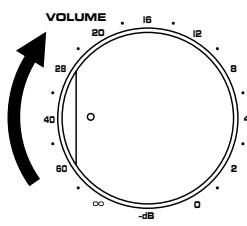

3 Turn until the desired volume is gained.

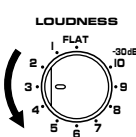

Using the PURE DIRECT switch

You can enjoy the purest possible sound from your audio sources by setting this switch so that the indicator illuminates. By doing so, the audio signals bypass the **BASS**, **TREBLE**, **BALANCE** and **LOUDNESS** controls, thus eliminating any alteration to the audio signals.

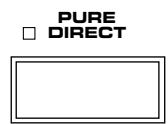

TUNING OPERATIONS

Normally, if station signals are strong and there is no interference, quick automatic-search tuning (AUTOMATIC TUNING) is possible. However, if signals of the station you want to select are weak, you must tune to it manually (MANUAL TUNING).

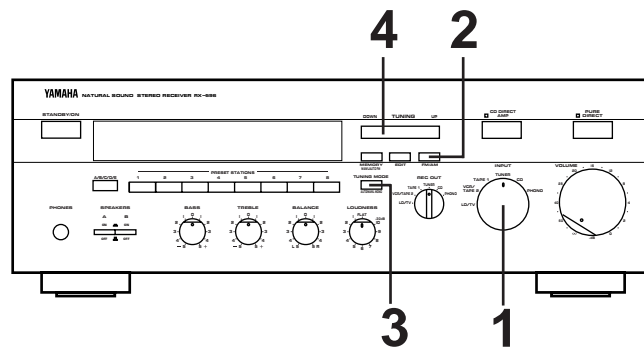

AUTOMATIC TUNING

- 1** Select "TUNER" as the input source.

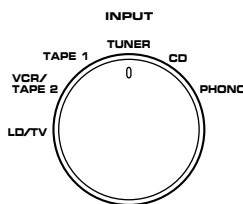

- 2** Select the reception band (FM or AM) confirming it on the display.

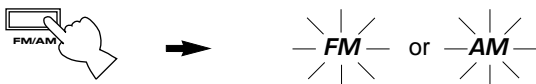

- 3** Press the Tuning Mode button to activate the 'AUTO TUNING' indicator on the display.

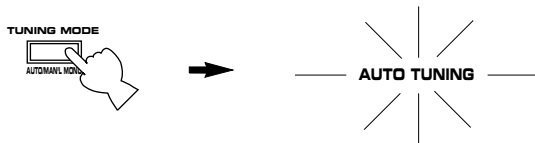

- 4** To tune to a higher frequency, press the right side once. To tune to a lower frequency, press the left side once.

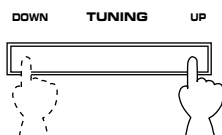

- * If the station where tuning search stops is not the desired one, press again.
- * If the tuning search does not stop at the desired station (because the signals of the station are weak), change to the MANUAL TUNING method.

MANUAL TUNING

- 1** Select "TUNER" as the input source.

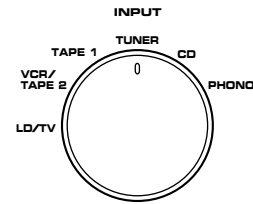

- 2** Select the reception band (FM or AM) confirming it on the display.

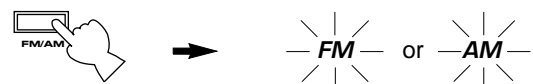

- 3** Press the Tuning Mode button to turn the "AUTO TUNING" indicator off.



- 4** Tune to a desired station manually.

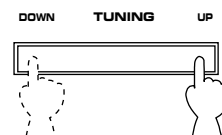

- * To continue tuning search, hold down the button.

Note
If you tune to an FM station manually, it is received in monaural mode automatically to increase the signal quality.

PRESET TUNING

MANUAL PRESET TUNING

This unit can store station frequencies selected by tuning operation. With this function, you can recall any desired station only by selecting the preset station number where it is stored. Up to 40 stations (8 stations x 5 groups) can be stored.

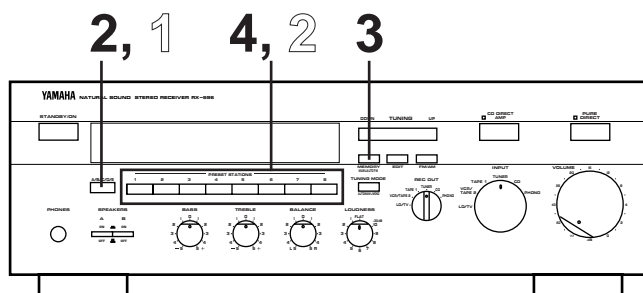

To store stations

- 1** Tune to a desired station.
(Refer to the previous page for tuning procedure.)
- 2** Select a desired group (A – E) of preset stations confirming it on the display.
- 3**

Flashes on and off for about 5 seconds.
- 4** Select a preset station number where you want to program the station before the “MEMORY” indicator goes off from the display.

Shows the displayed station has been programmed to A1.

* In the same way, program other stations to A2, A3 ... A8.
* You can program more stations to preset station numbers of other groups in the same way by selecting other groups in step 2.

To recall a preset station

- 1** Select the group of preset stations.
- 2** Select the preset station number.

Notes

- A new setting can be programmed in place of the former one.
- For presets, the setting of the reception mode (stereo or monaural) is stored along with the station frequency.

Memory back-up

The memory back-up circuit prevents the programmed data from being lost even if this unit is turned into the standby mode or the power plug is disconnected from the AC outlet or the power is cut due to temporary power failure. If, however, the power is cut for more than one week, the memory may be erased. If so, it can be re-programmed by simply following the PRESET TUNING steps.

AUTOMATIC PRESET TUNING

You can make use of an automatic preset tuning function for FM stations. With this function, this unit performs automatic tuning and stores FM stations with strong signals sequentially. Up to 40 stations are stored automatically in the same way as in the manual preset tuning method on page 17.

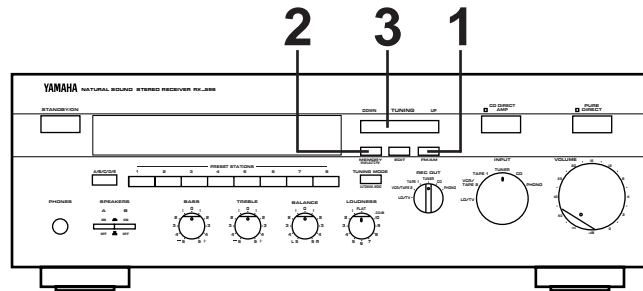

To store stations

1		→	
2		→	<p style="text-align: center;">Flashes.</p>
3			<p>To tune to higher frequencies, press right side once. To tune to lower frequencies, press left side once. * If the TUNING button is not pressed, in a while, the automatic preset tuning begins automatically toward higher frequencies.</p> <p>The automatic preset tuning begins from the frequency currently displayed. Received stations are programmed to A1, A2 ... A8 sequentially. * If more than 8 stations are received, they are also programmed to the preset station numbers of other groups (B, C, D and E) in that order.</p>

When the automatic preset tuning is finished;
The display shows the frequency of the last preset station. Check the contents and the number of preset stations by following the procedure of the section "To recall a preset station" on page 17.

To recall a preset station
Simply follow the procedure of the section "To recall a preset station" on page 17.

- Notes**
- You can replace a preset station by another FM or AM station manually by simply following the procedure of the section "To store stations" on page 17.
 - If the number of received stations is not enough to be stored up to E8, the search is finished automatically after searching all frequencies.
 - With this function, only FM stations with sufficient signal strength are stored automatically. If the station you want to program is weak in signal strength, tune to it in monaural manually and program it by following the procedure of the section "To store stations" on page 17.

If you want to store the first station received by the automatic preset tuning to a desired preset station number;

If, for example, you want to store the first received station to C5, select "C5" by using the **A/B/C/D/E** button and the **PRESET STATIONS** buttons after pressing the **MEMORY** button in step 2. Then press the **TUNING** button. The first received station is stored to C5, and next stations to C6, C7 ... sequentially.
If stations are stored up to E8, the automatic preset tuning is finished automatically.

EXCHANGING PRESET STATIONS

You can exchange the places of two preset stations with each other as shown below.

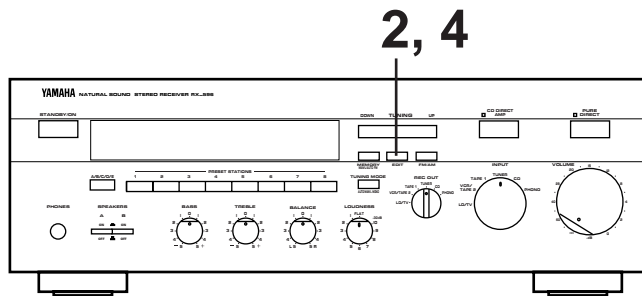

Example)

If you want to shift the preset station on E1 to A5, and vice versa.

1	Recall the preset station on E1 (by following the method of "To recall a preset station" on page 17).
2	
3	Recall the preset station on A5 by following the same method as in step 1.

4	
----------	--

TROUBLESHOOTING

If the unit fails to operate normally, check the following points to determine whether the fault can be corrected by the simple measures suggested. If it cannot be corrected, or if the fault is not listed in the SYMPTOM column, disconnect the power cord and contact your authorized YAMAHA dealer or service center for help.

	SYMPTOM	CAUSE	REMEDY
Amplifier	The unit fails to turn on when the STANDBY/ON switch is pressed.	Power cord is not plugged in or is not completely inserted.	Firmly plug in the power cord.
	It happens that this unit does not work normally.	There is an influence of strong external noise (lightning, excessive static electricity, etc.) or a misoperation on this unit while using this unit.	Turn this unit into the standby mode and disconnect the AC power cord from the AC outlet. After about 30 seconds pass, connect the power and operate this unit again.
	No sound or no picture.	Incorrect output cord connections.	Connect the cords properly. If the problem persists, the cords may be defective.
		Appropriate input source is not selected.	Select an appropriate input source with the INPUT selector.
		The SPEAKERS switches are not set properly.	Set the SPEAKERS switch which corresponds to the speakers to be used to the ON position.
		Speaker connections are not secure.	Secure the connections.
	The sound suddenly goes off.	The protection circuit has been activated because of short circuit etc.	Turn this unit into the standby mode, and then turn on to reset the protection circuit.
		The SLEEP timer has functioned.	Cancel the SLEEP timer function.
	Only one side speaker outputs the sound.	Incorrect setting of the BALANCE control.	Adjust it to the appropriate position.
		Incorrect cord connections.	Connect the cords properly. If the problem persists, the cords may be defective.
	Sound "hums".	Incorrect cord connections.	Firmly connect the audio plugs. If the problem persists, the cords may be defective.
		No connection from the turntable to the GND terminal.	Make the GND connection between the turntable and this unit.
	The volume level is low while playing a record.	The record is being played on a turntable with an MC cartridge.	The player should be connected to the unit through the MC head amplifier.
The volume level cannot be increased, or sound is distorted.	The component connected to the REC output terminals of this unit is turned off.	Turn the power to the component on.	
Sound level is low.	The LOUDNESS control is functioning.	Set the LOUDNESS control to the FLAT position.	
The INPUT selector will not function though it is turned.	The CD DIRECT AMP switch is ON.	Switch off the CD DIRECT AMP switch.	
Using the BASS, TREBLE, BALANCE and LOUDNESS controls does not affect the tone.	The CD DIRECT AMP or PURE DIRECT switch is ON.	The CD DIRECT AMP and PURE DIRECT switches must be switched OFF to use those controls.	
FM	FM stereo reception is noisy.	Because of the characteristics of FM stereo broadcasts, this is limited to cases where the transmitter is too far away or the antenna input is poor.	Check the antenna connections. Try using a high quality directional FM antenna. Set the TUNING MODE button to the manual tuning mode.
	There is distortion and clear reception cannot be obtained even with a good FM antenna.	There is multipath interference.	Adjust antenna placement to eliminate multipath interference.
	A desired station cannot be tuned in with the automatic tuning method.	The station is too weak.	Use the manual tuning method. Use a high quality directional FM antenna.
	Previously preset stations can no longer be tuned in.	This unit has been unplugged for a long period.	Repeat the presetting procedure.
AM	A desired station cannot be tuned in with the automatic tuning method.	Weak signal or loose antenna connections.	Tighten the AM loop antenna connections and rotate it for best reception. Use the manual tuning method.
	There are continuous crackling and hissing noises.	Noises result from lightning, fluorescent lamps, motors, thermostats and other electrical equipment.	Use an outdoor antenna and a ground wire. This will help somewhat but it is difficult to eliminate all the noises.
	There are buzzing and whining noises (especially in the evening).	A television set is being used nearby.	Relocate this unit away from the TV.
Remote control transmitter	The remote control transmitter does not work.	Direct sunlight or lighting (of an inverter type of fluorescent lamp etc.) is striking the remote control sensor of the main unit.	Change the position of the main unit.
		The batteries of this remote control transmitter are too weak.	Replace the batteries with new ones.
Others	The sound is degraded when listening with the headphones connected to the compact disc player or cassette deck that is connected with this unit.	This unit is in the standby mode.	Turn the power to this unit on.

SPECIFICATIONS

AUDIO SECTION

Minimum RMS Output Power per Channel
 8 ohms, 20 Hz to 20 kHz, 0.025% THD
80W+80W
 6 ohms, 20 Hz to 20 kHz, 0.05% THD
90W+90W

Maximum Power (EIAJ) [General model only]
 8 ohms, 1 kHz, 10% THD.....130W
 6 ohms, 1 kHz, 10% THD.....150W

Dynamic Power per Channel
 (by IHF Dynamic Headroom measuring
 method)
 8/6/4/2 ohms.....120/140/180/200W

Power Band Width
 8 ohms, 40W, 0.05% THD
10 Hz to 50 kHz

Damping Factor (SPEAKERS A)
 8 ohms, 20 Hz to 20 kHz.....240 or more

Input Sensitivity/Impedance
 PHONO MM.....2.5 mV/47 k-ohms
 CD/TAPE 1/VCR-TAPE 2/LD-TV
150 mV/47 k-ohms

Maximum Input Signal
 PHONO MM
 1 kHz, 0.003% THD115 mV

Output Level/Impedance
 REC OUT (PHONO).....150 mV/1.5 k-ohms

Headphones Jack Rated Output/Impedance
 Output Level (8 ohms, 0.025% THD)0.3V
 Impedance680 ohms

Frequency Response (20 Hz to 20 kHz)
 CD/TAPE 1/VCR-TAPE 2/LD-TV.....0±0.5 dB

RIAA Equalization Deviation
 PHONO MM0±0.5 dB

Total Harmonic Distortion (20 Hz to 20 kHz)
 PHONO MM to REC OUT
 3V.....0.003%
 CD/TAPE 1/VCR-TAPE 2/LD-TV to SP OUT
 40W/8 ohms.....0.01%

Signal-to-Noise Ratio (IHF-A Network)
 PHONO MM (5 mV Input Shorted).....88 dB
 CD DIRECT AMP SW: ON (Shorted)
110 dB

Residual Noise (IHF-A Network)
 CD DIRECT AMP SW: ON.....35 μ V
 PURE DIRECT SW: ON.....90 μ V

Channel Separation
 CD/TAPE 1/VCR-TAPE 2/LD-TV
 (Input 5.1 k-ohms Terminated, 1 kHz)
65 dB

Tone Control Characteristics
 BASS: Boost/cut±10 dB (20 Hz)
 Turnover Frequency.....350 Hz
 TREBLE: Boost/cut±10 dB (20 kHz)
 Turnover Frequency.....3.5 kHz

Continuously variable LOUDNESS Control
 (Level related equalization)
 Attenuation.....-30 dB (1 kHz)

VIDEO SECTION

Input Level/Impedance1 Vp-p/75 ohms
 Output Level/Impedance1 Vp-p/75 ohms

FM SECTION

Tuning Range
 [U.S.A. and Canada models]
87.5 to 107.9 MHz
 [Australia and General models]
87.5 to 108.0 MHz

50 dB Quieting Sensitivity (IHF, 75 ohms)
 Mono1.55 μ V (15.1 dBf)
 Stereo21 μ V (37.7 dBf)

Usable Sensitivity (75 ohms)
 (30 dB S/N Quieting, 1 kHz, 100% mod.)
0.8 μ V (9.3 dBf)
 DIN, Mono (S/N 26 dB)0.9 μ V
 DIN, Stereo (S/N 46 dB).....24 μ V

Image Response Ratio45 dB

IF Response Ratio.....70 dB

Spurious Response Ratio.....70 dB

AM Suppression Ratio.....55 dB

Capture Ratio1.5 dB

Alternate Channel Selectivity85 dB

Signal-to-Noise Ratio (IHF)
 Mono/Stereo80 dB/75 dB

Harmonic Distortion (1 kHz)
 Mono/Stereo0.1/0.2%

Stereo Separation (1 kHz).....50 dB

Frequency Response
 20 Hz to 15 kHz.....0 ±1.5 dB

AM SECTION

Tuning Range
 [U.S.A., Canada and General models]
530 to 1,710 kHz
 [Australia model]531 to 1,611 kHz

Usable Sensitivity.....100 μ V/m

Selectivity32 dB

Signal-to-Noise Ratio50 dB

Image Response Ratio40 dB

Spurious Response Ratio50 dB

Harmonic Distortion (400 Hz).....0.3%

AUDIO SECTION

Output Level/Impedance
 FM (100% mod., 1 kHz)
500 mV/2.2 k-ohm
 AM (30% mod., 400 Hz)
150 mV/2.2 k-ohm

GENERAL

Power Supply
 [U.S.A. and Canada models]
AC 120V, 60 Hz
 [Australia model]AC 240V, 50 Hz
 [General model]
AC 110/120/220/240V, 60/50 Hz

Power Consumption
 [U.S.A. model]190W
 [Canada model]250W, 320VA
 [Australia and General models]210W

Maximum Power Consumption
 [General model only]450W

AC Outlets
 2 SWITCHED OUTLETS
 [U.S.A., Canada and General models]
100W max. total
 1 SWITCHED OUTLET
 [Australia model].....100W max. total

Dimensions (W x H x D)
435 x 151 x 389.8 mm
 (17-1/8" x 5-15/16" x 15-3/8")

Weight.....9.5 kg (20 lbs. 14 oz.)

Accessories.....AM loop antenna
 Indoor FM antenna
 Remote control transmitter
 Batteries
 Antenna adapter
 (U.S.A. and Canada models only)

Specifications are subject to change without notice.

YAMAHA

YAMAHA ELECTRONICS CORPORATION, USA 6660 ORANGETHORPE AVE., BUENA PARK, CALIF. 90620, U.S.A.
YAMAHA CANADA MUSIC LTD. 135 MILNER AVE., SCARBOROUGH, ONTARIO M1S 3R1, CANADA
YAMAHA ELECTRONIK EUROPA G.m.b.H. SIEMENSSTR. 22-34, 25462 RELLINGEN BEI HAMBURG, F.R. OF GERMANY
YAMAHA ELECTRONIQUE FRANCE S.A. RUE AMBROISE CROIZAT BP70 CROISSY-BEAUBOURG 77312 MARNE-LA-VALLEE CEDEX02, FRANCE
YAMAHA ELECTRONICS (UK) LTD. YAMAHA HOUSE, 200 RICKMANSWORTH ROAD WATFORD, HERTS WD1 7JS, ENGLAND
YAMAHA SCANDINAVIA A.B. J A WETTERGRENS GATA 1, BOX 30053, 400 43 VÄSTRA FRÖLUNDA, SWEDEN
YAMAHA MUSIC AUSTRALIA PTY, LTD. 17-33 MARKET ST., SOUTH MELBOURNE, 3205 VIC., AUSTRALIA

YAMAHA CORPORATION
VZ85310 Printed in Malaysia